

IP20 SELV 

Driver LCI 65 W 1400/1750 mA TEC Ip

TEC series

Product description

- Fixed output built-in LED Driver
- Constant current LED Driver
- Output current 1,400 or 1,750 mA
- Max. output power 65 W
- Nominal life-time up to 50,000 h
- For luminaires of protection class I and protection class II
- Temperature protection as per EN 61347-2-13 C5e
- 5-year guarantee

Properties

- Low-profile metal casing with white cover
- Type of protection IP20

Functions

- Overtemperature protection
- Overload protection
- Short-circuit protection
- No-load protection

Technical data

Rated supply voltage	220 – 240 V
AC voltage range	198 – 264 V
Typ. rated current (at 230 V, 50 Hz, full load)	0.32 A
Mains frequency	50 / 60 Hz
Overvoltage protection	300 V AC, 1 h
Leakage current (at 230 V, 50 Hz, full load)	< 550 µA
Max. input power	75 W
Output power	65 W
THD (at 230 V, 50 Hz, full load)	< 20 %
Output current tolerance [®]	± 7,5 %
Typ. current ripple (at 230 V, 50 Hz, full load)	± 30 %
Turn on time (at 230 V, 50 Hz, full load)	≤ 0,7 s
Turn off time (at 230 V, 50 Hz, full load)	≤ 0,7 s
Hold on time at power failure	0 s
Ambient temperature t_a	-20 ... +50 °C
Ambient temperature t_a (at life-time 50,000 h)	40 °C
Max. casing temperature t_c	80 °C
Storage temperature t_s	-40 ... +80 °C
Dimensions L x W x H	360 x 30 x 21 mm

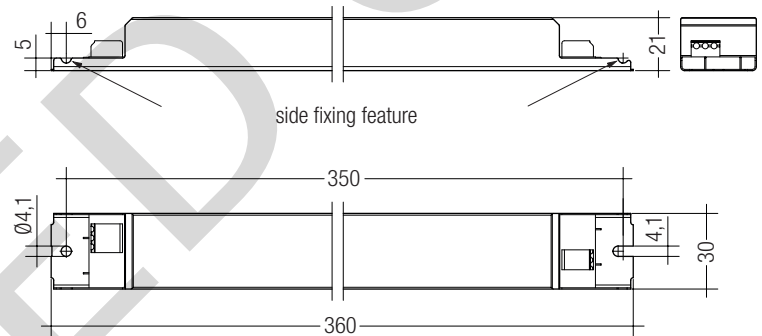

Ordering data

Type	Article number	Packaging, carton	Packaging, low volume	Packaging, high volume	Weight per pc.
LCI 65W 1400mA TEC Ip	87500229	50 pc(s).	650 pc(s).	1,950 pc(s).	0.257 kg
LCI 65W 1750mA TEC Ip	87500230	50 pc(s).	650 pc(s).	1,950 pc(s).	0.260 kg



Standards, page 3

Wiring diagrams and installation examples, page 4

Specific technical data

Type	Output current [Ⓢ]	Typ. power consumption (at 230 V, 50 Hz, full load)	Power factor at full load [Ⓢ]	Efficiency at full load [Ⓢ]	Power factor at min. load [Ⓢ]	Efficiency at min. load [Ⓢ]	Min. forward voltage [Ⓢ]	Max. forward voltage [Ⓢ]	Max. output voltage	Max. peak output current at full load ^{Ⓢ②}	Max. peak output current at min. load ^{Ⓢ②}
LCI 65W 1400mA TEC Ip	1,400 mA	72.0 W	0.98	90.0 %	0.93C	87.0 %	23.0 V	46.5 V	55 V	2,160 mA	2,420 mA
LCI 65W 1750mA TEC Ip	1,750 mA	72.5 W	0.98	89.5 %	0.93C	86.0 %	18.5 V	37.0 V	43 V	2,750 mA	2,910 mA

[Ⓢ] Test result at 230 V, 50 Hz.

^② The trend between min. and full load is linear.

[Ⓢ] Output current is mean value.

Standards

EN 55015
 EN 61000-3-2
 EN 61000-3-3
 EN 61347-1
 EN 61347-2-13
 EN 61547
 EN 62384

Overload protection

If the output voltage range is exceeded the LED Driver reduces the LED output current. After elimination of the overload the nominal operation is restored automatically.

Overtemperature protection

The LED Driver is protected against temporary thermal overheating. If the temperature limit is exceeded the output current is reduced to limit t_c at a certain level. The temperature protection is activated typically at 10 °C above t_c max.

Short-circuit behaviour

In case of a short circuit on the secondary side (LED) the LED Driver switches into hic-cup mode. After the removal of the short-circuit fault the LED Driver will recover automatically.

No-load operation

The LED Driver works in constant voltage mode. In no-load operation the output voltage will not exceed the specified max. output voltage (see page 1).

Expected life-time

Type	t_a	40 °C	50 °C	60 °C
LCI 65W xxx mA TEC Ip	t_c	70 °C	80 °C	x
	Life-time	50,000 h	30,000 h	x

The LED Drivers are designed for a life-time stated above under reference conditions and with a failure probability of less than 10 %.

Maximum loading of automatic circuit breakers

Automatic circuit breaker type	Installation Ø								Inrush current	
	C10	C13	C16	C20	B10	B13	B16	B20	I_{max}	Time
Installation Ø	1.5 mm ²	1.5 mm ²	1.5 mm ²	2.5 mm ²	1.5 mm ²	1.5 mm ²	1.5 mm ²	2.5 mm ²		
LCI 65W 1400mA TEC Ip	20	30	40	50	16	24	32	40	13 A	50 µs
LCI 65W 1750mA TEC Ip	20	30	40	50	16	24	32	40	13 A	50 µs

Harmonic distortion in the mains supply (at 230 V / 50 Hz and full load) in %

	THD	3.	5.	7.	9.	11.
LCI 65W 1400mA TEC C	20	4	1	1	1	1
LCI 65W 1750mA TEC C	20	5	1	1	2	1

Storage conditions

Humidity: 5 % up to max. 85 %, not condensed (max. 56 days/year at 85 %)

Storage temperature: -40 °C up to max. +80 °C

The devices have to be within the specified temperature range (t_a) before they can be operated.

Installation instructions

The LED module and all contact points within the wiring must be sufficiently insulated against 0.5 kV surge voltage.
Air and creepage distance must be maintained.

Replace LED module

1. Mains off
2. Remove LED module
3. Wait for 10 seconds
4. Connect LED module again

Hot plug-in or secondary switching of LEDs is not permitted and may cause a very high current to the LEDs.

Wiring type and cross section

Solid wire with a cross section of 0.5 – 1.5 mm². Strip 8 – 9 mm of insulation from the cables to ensure perfect operation of terminals.

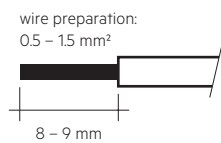
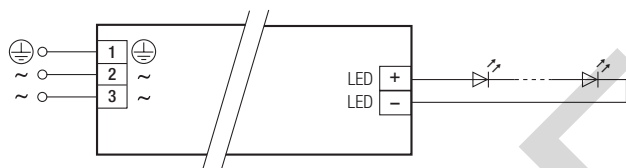
**Wiring diagram****Wiring guidelines**

- All connections must be kept as short as possible to ensure good EMI behaviour.
- Mains leads should be kept apart from LED Driver and other leads (ideally 5 – 10 cm distance)
- Max. length of output wires is 2 m.
- Secondary switching is not permitted.
- Incorrect wiring can damage LED modules.
- The wiring must be protected against short circuits to earth (sharp edged metal parts, metal cable clips, louver, etc.).

Isolation and electric strength testing of luminaires

Electronic devices can be damaged by high voltage. This has to be considered during the routine testing of the luminaires in production.

According to IEC 60598-1 Annex Q (informative only!) or ENEC 303-Annex A, each luminaire should be submitted to an isolation test with 500 V_{DC} for 1 second. This test voltage should be connected between the interconnected phase and neutral terminals and the earth terminal.
The isolation resistance must be at least 2 MΩ.

As an alternative, IEC 60598-1 Annex Q describes a test of the electrical strength with 1500 V_{AC} (or 1.414 x 1500 V_{DC}). To avoid damage to the electronic devices this test must not be conducted.

Release of the wiring

Loosen wire through twisting and pulling or using a Ø 1 mm release tool.

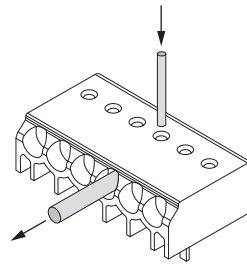
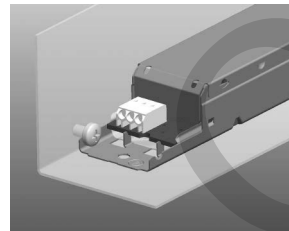
**Side fixing feature**

Screw M4, screw head diameter 8–10 mm

Additional information

Additional technical information at www.tridonic.com → Technical Data

Guarantee conditions at www.tridonic.com → Services

Life-time declarations are informative and represent no warranty claim.
No warranty if device was opened.

Diagrams LCI 65W 1400mA TEC Ip

Efficiency vs load

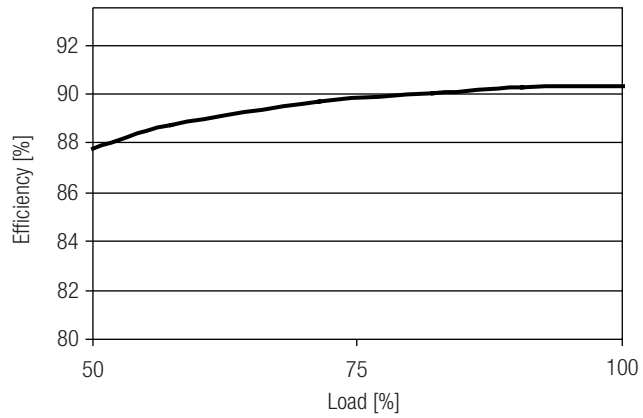

Power factor vs load

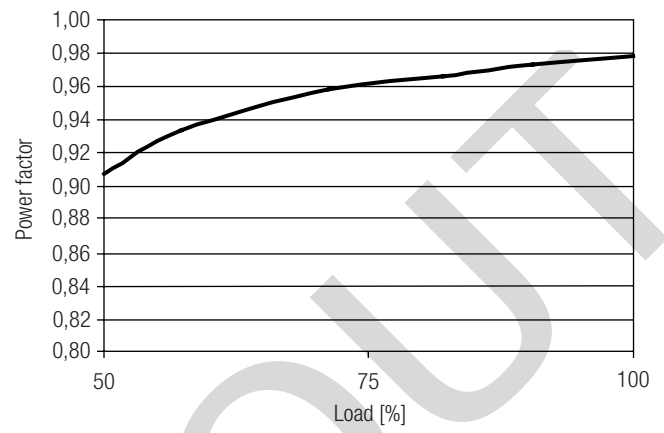

THD vs load

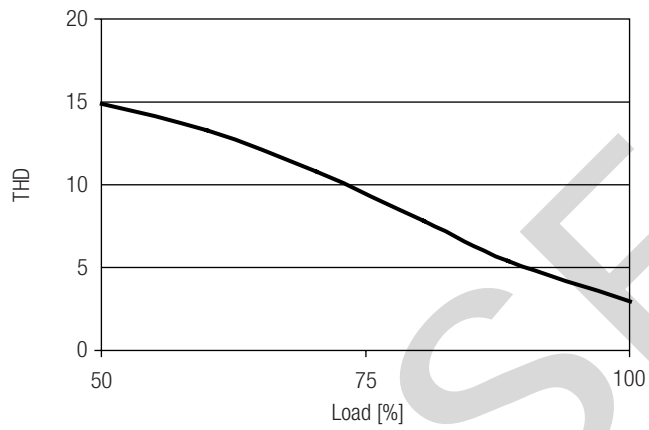

Diagrams LCI 65W 1750mA TEC Ip

Efficiency vs load

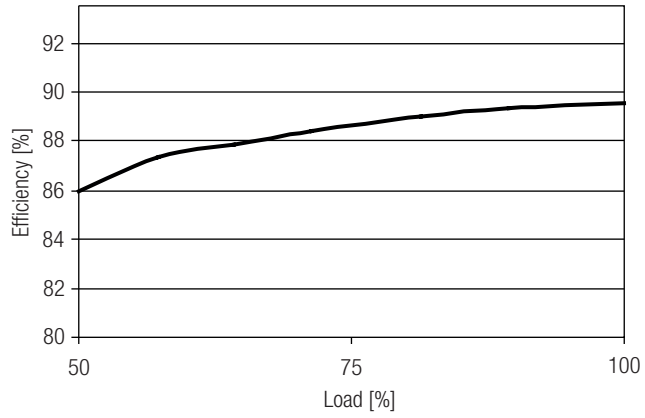

Power factor vs load

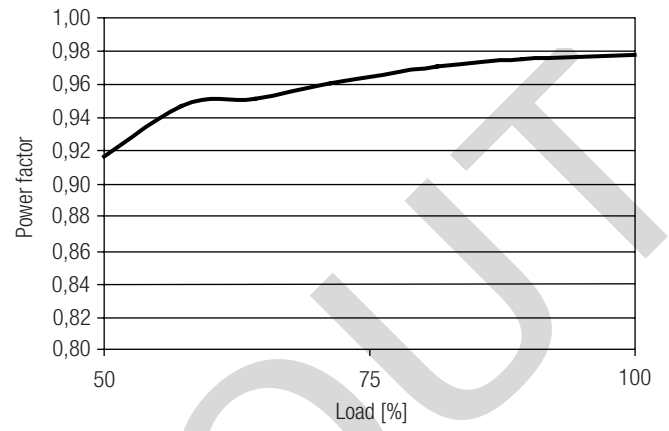

THD vs load

