

Module SLE G7 ADV

Modules SLE advanced



LES13 + LES15 with housing



LES21 with housing



LES09

Product description

- _ For spotlights and downlights
- _ TIM variants for easy and fast assembly
- _ For operating with SELV Driver suitable
- _ Excellent thermal management by COB technology
- _ Uniform radiation with Dam&Fill technology
- _ Integrated LED module
- _ Cooling required
- _ Flexible operating mode
- _ 4,100 K CRI90 module COI approved acc. to AS/NZS1680.2.5:1997
- _ HE ... High Efficiency, NM ... Nominal Mode, HO ... High Output
- _ Long lifetime: 55,000 hours
- _ 5 years guarantee (conditions at <https://www.tridonic.com/manufacture-guarantee-conditions>)

Optical properties

- _ Colour temperatures 2,700, 3,100, 3,500 and 4,100 K
- _ Useful luminous flux 8.553 lm at Irated and tp = 25 °C
- _ Efficacy of the LED module 172 lm/W at Irated and tp = 25 °C
- _ High colour rendering index CRI > 80 and CRI > 90
- _ Small colour tolerance (MacAdam 3)

Mechanical properties

- _ Module dimension LES09, LES13, LES15, LES17 and LES21
- _ Housing with Snap-On feature for easy reflector mounting
- _ 50 mm housing with 35 mm mounting hole distance acc. to Zhaga
- _ Fixing holes for M3 screws

System solution

- _ Combine Tridonic's LED modules and dimmable drivers to achieve an outstanding system efficacy (configuration possible via <https://setbuilder.tridonic.com/>)

Website

<http://www.tridonic.com/28002510>



Spotlights



Downlights



Linear



Area



Floor | Wall



Free-standing



Street



Decorative



High bay

Module SLE G7 ADV

Modules SLE advanced

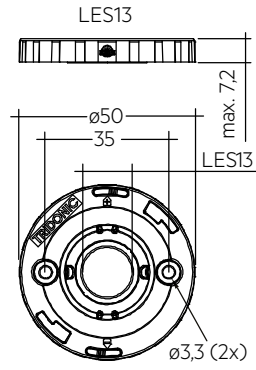

Dimensions in mm, *optical LES

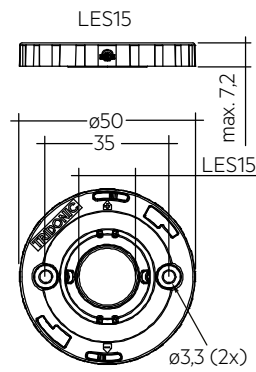

Dimensions in mm, *optical LES

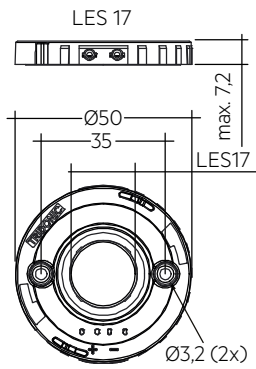

Dimensions in mm, *optical LES

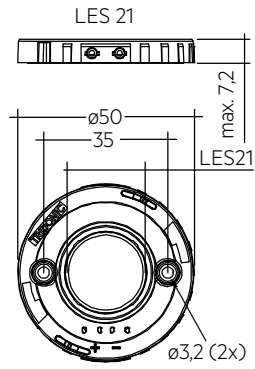

Dimensions in mm, *optical LES

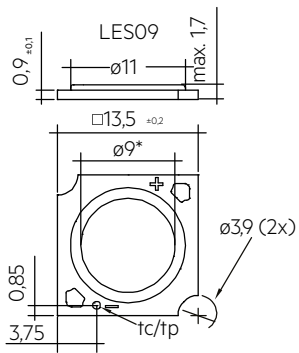

Dimensions in mm, *optical LES

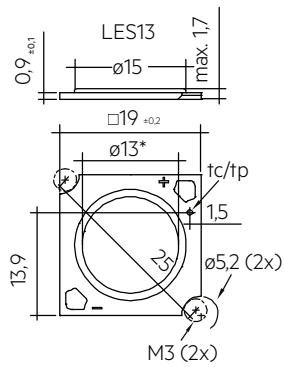

Dimensions in mm, *optical LES

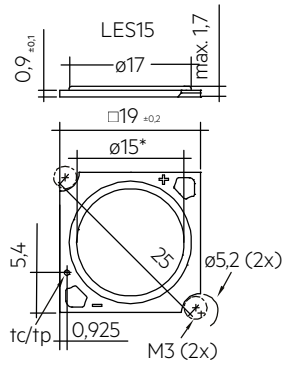

Dimensions in mm, *optical LES

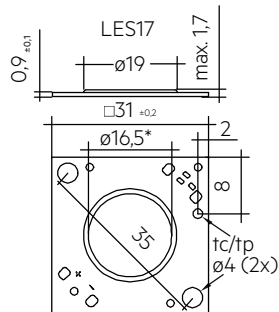

Dimensions in mm, *optical LES

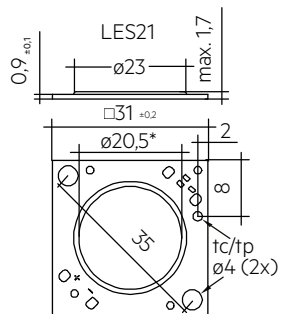

Dimensions in mm, *optical LES

Ordering data

Type	Article number	Colour temperature	Colour rendering index CRI	Packaging, carton	Weight per pc.
SLE G7 09mm – Without housing					
SLE G7 09mm 1200lm 830 R ADV	28002510	3,100 K	>80	20 pc(s).	0.001 kg
SLE G7 09mm 1200lm 840 R ADV	28002511	4,100 K	>80	20 pc(s).	0.001 kg
SLE G7 09mm 1200lm 927 R ADV	28002512	2,700 K	>90	20 pc(s).	0.001 kg
SLE G7 09mm 1200lm 930 R ADV	28002513	3,100 K	>90	20 pc(s).	0.001 kg
SLE G7 09mm 1200lm 940 R ADV	28002514	4,100 K	>90	20 pc(s).	0.001 kg
SLE G7 13mm – Without housing					
SLE G7 13mm 3000lm 827 R ADV	28002515	2,700 K	>80	20 pc(s).	0.001 kg
SLE G7 13mm 3000lm 830 R ADV	28002516	3,100 K	>80	20 pc(s).	0.001 kg
SLE G7 13mm 3000lm 835 R ADV	28002517	3,500 K	>80	20 pc(s).	0.001 kg
SLE G7 13mm 3000lm 840 R ADV	28002518	4,100 K	>80	20 pc(s).	0.001 kg
SLE G7 13mm 3000lm 927 R ADV	28002519	2,700 K	>90	20 pc(s).	0.001 kg
SLE G7 13mm 3000lm 930 R ADV	28002520	3,100 K	>90	20 pc(s).	0.001 kg
SLE G7 13mm 3000lm 935 R ADV	28002521	3,500 K	>90	20 pc(s).	0.001 kg
SLE G7 13mm 3000lm 940 R ADV	28002522	4,100 K	>90	20 pc(s).	0.001 kg
SLE G7 15mm – Without housing					
SLE G7 15mm 4000lm 827 R ADV	28002523	2,700 K	>80	20 pc(s).	0.002 kg
SLE G7 15mm 4000lm 830 R ADV	28002524	3,100 K	>80	20 pc(s).	0.002 kg
SLE G7 15mm 4000lm 840 R ADV	28002526	4,100 K	>80	20 pc(s).	0.002 kg
SLE G7 15mm 4000lm 927 R ADV	28002527	2,700 K	>90	20 pc(s).	0.002 kg
SLE G7 15mm 4000lm 930 R ADV	28002528	3,100 K	>90	20 pc(s).	0.002 kg
SLE G7 15mm 4000lm 940 R ADV	28002530	4,100 K	>90	20 pc(s).	0.002 kg
SLE G7 17mm – Without housing					
SLE G7 17mm 5000lm 827 R ADV	28002588	2,700 K	>80	10 pc(s).	0.002 kg
SLE G7 17mm 5000lm 830 R ADV	28002589	3,100 K	>80	10 pc(s).	0.002 kg
SLE G7 17mm 5000lm 835 R ADV	28002590	3,500 K	>80	10 pc(s).	0.002 kg
SLE G7 17mm 5000lm 840 R ADV	28002591	4,100 K	>80	10 pc(s).	0.002 kg
SLE G7 17mm 5000lm 927 R ADV	28002592	2,700 K	>90	10 pc(s).	0.002 kg
SLE G7 17mm 5000lm 930 R ADV	28002593	3,100 K	>90	10 pc(s).	0.002 kg
SLE G7 17mm 5000lm 935 R ADV	28002594	3,500 K	>90	10 pc(s).	0.002 kg
SLE G7 17mm 5000lm 940 R ADV	28002595	4,100 K	>90	10 pc(s).	0.002 kg
SLE G7 21mm – Without housing					
SLE G7 21mm 6000lm 827 R ADV	28002596	2,700 K	>80	10 pc(s).	0.002 kg
SLE G7 21mm 6000lm 830 R ADV	28002597	3,100 K	>80	10 pc(s).	0.002 kg
SLE G7 21mm 6000lm 840 R ADV	28002599	4,100 K	>80	10 pc(s).	0.002 kg
SLE G7 21mm 6000lm 927 R ADV	28002600	2,700 K	>90	10 pc(s).	0.002 kg
SLE G7 21mm 6000lm 930 R ADV	28002601	3,100 K	>90	10 pc(s).	0.002 kg
SLE G7 21mm 6000lm 940 R ADV	28002603	4,100 K	>90	10 pc(s).	0.002 kg
SLE G7 13mm – With housing					
SLE G7 13mm 3000lm 830 H ADV	28002559	3,100 K	>80	50 pc(s).	0.007 kg
SLE G7 13mm 3000lm 840 H ADV	28002560	4,100 K	>80	50 pc(s).	0.007 kg
SLE G7 13mm 3000lm 927 H ADV	28004044	2,700 K	>90	50 pc(s).	0.007 kg
SLE G7 13mm 3000lm 930 H ADV	28002561	3,100 K	>90	50 pc(s).	0.007 kg
SLE G7 13mm 3000lm 935 H ADV	28004045	3,500 K	>90	50 pc(s).	0.007 kg
SLE G7 13mm 3000lm 940 H ADV	28002562	4,100 K	>90	50 pc(s).	0.007 kg
SLE G7 15mm – With housing					
SLE G7 15mm 4000lm 830 H ADV	28002567	3,100 K	>80	50 pc(s).	0.007 kg
SLE G7 15mm 4000lm 840 H ADV	28002568	4,100 K	>80	50 pc(s).	0.007 kg
SLE G7 15mm 4000lm 930 H ADV	28002569	3,100 K	>90	50 pc(s).	0.007 kg
SLE G7 15mm 4000lm 940 H ADV	28002570	4,100 K	>90	50 pc(s).	0.007 kg
SLE G7 17mm – With housing					
SLE G7 17mm 5000lm 827 H ADV	28002612	2,700 K	>80	50 pc(s).	0.007 kg
SLE G7 17mm 5000lm 830 H ADV	28002613	3,100 K	>80	50 pc(s).	0.007 kg
SLE G7 17mm 5000lm 835 H ADV	28002614	3,500 K	>80	50 pc(s).	0.007 kg
SLE G7 17mm 5000lm 840 H ADV	28002615	4,100 K	>80	50 pc(s).	0.007 kg
SLE G7 17mm 5000lm 927 H ADV	28002616	2,700 K	>90	50 pc(s).	0.007 kg
SLE G7 17mm 5000lm 930 H ADV	28002617	3,100 K	>90	50 pc(s).	0.007 kg
SLE G7 17mm 5000lm 935 H ADV	28002618	3,500 K	>90	50 pc(s).	0.007 kg
SLE G7 17mm 5000lm 940 H ADV	28002619	4,100 K	>90	50 pc(s).	0.007 kg
SLE G7 21mm – With housing					
SLE G7 21mm 6000lm 827 H ADV	28002631	2,700 K	>80	50 pc(s).	0.007 kg
SLE G7 21mm 6000lm 830 H ADV	28002632	3,100 K	>80	50 pc(s).	0.007 kg
SLE G7 21mm 6000lm 840 H ADV	28002633	4,100 K	>80	50 pc(s).	0.007 kg
SLE G7 21mm 6000lm 927 H ADV	28002634	2,700 K	>90	50 pc(s).	0.007 kg
SLE G7 21mm 6000lm 930 H ADV	28002635	3,100 K	>90	50 pc(s).	0.007 kg
SLE G7 21mm 6000lm 940 H ADV	28002637	4,100 K	>90	50 pc(s).	0.007 kg
SLE G7 15mm – With housing and thermal interface material					
SLE G7 15mm 4000lm 830 H ADV T	28002670	3,100 K	>80	50 pc(s).	0.007 kg
SLE G7 15mm 4000lm 840 H ADV T	28002671	4,100 K	>80	50 pc(s).	0.007 kg

Type	Article number	Colour temperature	Colour rendering index CRI	Packaging, carton	Weight per pc.
SLE G7 15mm 4000lm 930 H ADV T	28002672	3,100 K	>90	50 pc(s).	0.007 kg
SLE G7 15mm 4000lm 940 H ADV T	28002673	4,100 K	>90	50 pc(s).	0.007 kg
SLE G7 17mm – With housing and thermal interface material					
SLE G7 17mm 5000lm 830 H ADV T	28002620	3,100 K	>80	50 pc(s).	0.007 kg
SLE G7 17mm 5000lm 840 H ADV T	28002621	4,100 K	>80	50 pc(s).	0.007 kg
SLE G7 17mm 5000lm 930 H ADV T	28002622	3,100 K	>90	50 pc(s).	0.007 kg
SLE G7 17mm 5000lm 935 H ADV T	28002623	3,500 K	>90	50 pc(s).	0.007 kg
SLE G7 17mm 5000lm 940 H ADV T	28002624	4,100 K	>90	50 pc(s).	0.007 kg
SLE G7 21mm – With housing and thermal interface material					
SLE G7 21mm 6000lm 830 H ADV T	28002638	3,100 K	>80	50 pc(s).	0.007 kg
SLE G7 21mm 6000lm 840 H ADV T	28002639	4,100 K	>80	50 pc(s).	0.007 kg
SLE G7 21mm 6000lm 930 H ADV T	28002640	3,100 K	>90	50 pc(s).	0.007 kg
SLE G7 21mm 6000lm 940 H ADV T	28002641	4,100 K	>90	50 pc(s).	0.007 kg

Technical data

Beam characteristic	115°
Ambient temperature t_a	-30 ... +80 °C
t_p rated	65 °C
t_c ^①	105 °C
I _{rated} for LES09	350 mA
I _{rated} for LES13	500 mA
I _{rated} for LES15	900 mA
I _{rated} for LES17	1,050 mA
I _{rated} for LES21	1,400 mA
I _{max} for LES09 ^①	550 mA
I _{max} for LES13 ^①	990 mA
I _{max} for LES15 ^①	1,320 mA
I _{max} for LES17 ^①	1,540 mA
I _{max} for LES21 ^①	2,200 mA
Max. permissible LF current ripple for LES09	720 mA
Max. permissible LF current ripple for LES13	1,440 mA
Max. permissible LF current ripple for LES15	1,920 mA
Max. permissible LF current ripple for LES17	1,680 mA
Max. permissible LF current ripple for LES21	2,400 mA
Max. permissible peak current for LES09	1,080 mA / max. 8 ms
Max. permissible peak current for LES13	1,800 mA / max. 8 ms
Max. permissible peak current for LES15	2,160 mA / max. 8 ms
Max. permissible peak current for LES17	2,520 mA / max. 8 ms
Max. permissible peak current for LES21	3,600 mA / max. 8 ms
Max. working voltage for insulation SELV ^②	< 60 V
Insulation test voltage	0.5 kV
CTI of the printed circuit board	≥ 600
Colour tolerance	3 SDCM
ESD classification	Severity level 4
Risk group (IEC 62471) for LES09 (at I _{max})	RG2 (E _{thr} = 1635 lx, RG1 at d ≥ 897 mm)
Risk group (IEC 62471) for LES09 (at I ≤ 500 mA)	RG1
Risk group (IEC 62471) for LES13 (at I _{max})	RG2 (E _{thr} = 1635 lx, RG1 at d ≥ 1,220 mm)
Risk group (IEC 62471) for LES13 (at I ≤ 900 mA)	RG1
Risk group (IEC 62471) for LES15 (at I _{max})	RG2 (E _{thr} = 1635 lx, RG1 at d = 1,410 mm)
Risk group (IEC 62471) for LES15 (at I ≤ 1200 mA)	RG1
Risk group (IEC 62471) for LES17 (at I _{max})	RG2 (E _{thr} = 1771 lx, RG1 at d = 1,145 mm)
Risk group (IEC 62471) for LES17 (at I ≤ 1400 mA)	RG1
Risk group (IEC 62471) for LES21	RG1
Type of protection	IP00
Lumen maintenance L70B50	55,000 h
Guarantee (conditions at www.tridonic.com)	5 Year(s)

Approval marks



Standards

EN 62031, EN 62471, EN 62717, IEC 61000-4-2, UL 8750

Specific technical data

Type	Article number	Photometric code	Useful luminous flux at $t_p = 25^\circ\text{C}$	Expected luminous flux at t_p rated	Typ. forward current	Min. forward voltage at t_p rated	Max. forward voltage at $t_p = 25^\circ\text{C}$	Power consumption P_{on} at $t_p = 25^\circ\text{C}$	Efficacy of the module at $t_p = 25^\circ\text{C}$	Expected efficacy of the module at t_p rated	Colour rendering index-CRI
SLE 09mm 1200lm – Operating mode HE at 250 mA											
SLE G7 09mm 1200lm 830 R ADV	28002510	830/359	-	1,320 lm	250 mA	31,5 V	37,5 V	-	-	154 lm/W	>80
SLE G7 09mm 1200lm 840 R ADV	28002511	840/359	-	1,385 lm	250 mA	31,5 V	37,5 V	-	-	161 lm/W	>80
SLE G7 09mm 1200lm 927 R ADV	28002512	927/359	-	1,050 lm	250 mA	31,5 V	37,5 V	-	-	123 lm/W	>90
SLE G7 09mm 1200lm 930 R ADV	28002513	930/359	-	1,118 lm	250 mA	31,5 V	37,5 V	-	-	131 lm/W	>90
SLE G7 09mm 1200lm 940 R ADV	28002514	940/359	-	1,172 lm	250 mA	31,5 V	37,5 V	-	-	137 lm/W	>90
SLE 09mm 1200lm – Operating mode NM at 350 mA											
SLE G7 09mm 1200lm 830 R ADV	28002510	830/359	1,926 lm	1,779 lm	350 mA	32,4 V	38,6 V	12,5 W	154 lm/W	144 lm/W	>80
SLE G7 09mm 1200lm 840 R ADV	28002511	840/359	2,014 lm	1,869 lm	350 mA	32,4 V	38,6 V	12,5 W	161 lm/W	151 lm/W	>80
SLE G7 09mm 1200lm 927 R ADV	28002512	927/359	1,512 lm	1,406 lm	350 mA	32,4 V	38,6 V	12,5 W	121 lm/W	113 lm/W	>90
SLE G7 09mm 1200lm 930 R ADV	28002513	930/359	1,627 lm	1,507 lm	350 mA	32,4 V	38,6 V	12,5 W	130 lm/W	122 lm/W	>90
SLE G7 09mm 1200lm 940 R ADV	28002514	940/359	1,699 lm	1,572 lm	350 mA	32,4 V	38,6 V	12,5 W	136 lm/W	128 lm/W	>90
SLE 09mm 1200lm – Operating mode HO at 500 mA											
SLE G7 09mm 1200lm 830 R ADV	28002510	830/359	-	2,425 lm	500 mA	32,8 V	39,0 V	-	-	136 lm/W	>80
SLE G7 09mm 1200lm 840 R ADV	28002511	840/359	-	2,537 lm	500 mA	32,8 V	39,0 V	-	-	142 lm/W	>80
SLE G7 09mm 1200lm 927 R ADV	28002512	927/359	-	1,907 lm	500 mA	32,8 V	39,0 V	-	-	107 lm/W	>90
SLE G7 09mm 1200lm 930 R ADV	28002513	930/359	-	2,046 lm	500 mA	32,8 V	39,0 V	-	-	115 lm/W	>90
SLE G7 09mm 1200lm 940 R ADV	28002514	940/359	-	2,138 lm	500 mA	32,8 V	39,0 V	-	-	120 lm/W	>90
SLE 13mm 3000lm – Operating mode HE at 350 mA											
SLE G7 13mm 3000lm 827 R ADV	28002515	827/359	-	1,793 lm	350 mA	30,9 V	36,8 V	-	-	152 lm/W	>80
SLE G7 13mm 3000lm 830 R ADV	28002516	830/359	-	1,897 lm	350 mA	30,9 V	36,8 V	-	-	161 lm/W	>80
SLE G7 13mm 3000lm 835 R ADV	28002517	835/359	-	1,976 lm	350 mA	30,9 V	36,8 V	-	-	167 lm/W	>80
SLE G7 13mm 3000lm 840 R ADV	28002518	840/359	-	2,008 lm	350 mA	30,9 V	36,8 V	-	-	170 lm/W	>80
SLE G7 13mm 3000lm 927 R ADV	28002519	927/359	-	1,545 lm	350 mA	30,9 V	36,8 V	-	-	131 lm/W	>90
SLE G7 13mm 3000lm 930 R ADV	28002520	930/359	-	1,627 lm	350 mA	30,9 V	36,8 V	-	-	137 lm/W	>90
SLE G7 13mm 3000lm 935 R ADV	28002521	935/359	-	1,591 lm	350 mA	30,9 V	36,8 V	-	-	135 lm/W	>90
SLE G7 13mm 3000lm 940 R ADV	28002522	940/359	-	1,672 lm	350 mA	30,9 V	36,8 V	-	-	142 lm/W	>90
SLE G7 13mm 3000lm 830 H ADV	28002559	830/359	-	1,595 lm	350 mA	30,9 V	36,8 V	-	-	135 lm/W	>80
SLE G7 13mm 3000lm 840 H ADV	28002560	840/359	-	1,688 lm	350 mA	30,9 V	36,8 V	-	-	143 lm/W	>80
SLE G7 13mm 3000lm 927 H ADV	28004044	927/359	-	1,298 lm	350 mA	30,9 V	36,8 V	-	-	110 lm/W	>90
SLE G7 13mm 3000lm 930 H ADV	28002561	930/359	-	1,368 lm	350 mA	30,9 V	36,8 V	-	-	115 lm/W	>90
SLE G7 13mm 3000lm 935 H ADV	28004045	935/359	-	1,337 lm	350 mA	30,9 V	36,8 V	-	-	113 lm/W	>90
SLE G7 13mm 3000lm 940 H ADV	28002562	940/359	-	1,405 lm	350 mA	30,9 V	36,8 V	-	-	119 lm/W	>90
SLE 13mm 3000lm – Operating mode NM at 500 mA											
SLE G7 13mm 3000lm 827 R ADV	28002515	827/359	2,680 lm	2,491 lm	500 mA	31,8 V	37,9 V	17,6 W	152 lm/W	143 lm/W	>80
SLE G7 13mm 3000lm 830 R ADV	28002516	830/359	2,827 lm	2,626 lm	500 mA	31,8 V	37,9 V	17,6 W	161 lm/W	151 lm/W	>80
SLE G7 13mm 3000lm 835 R ADV	28002517	835/359	2,930 lm	2,724 lm	500 mA	31,8 V	37,9 V	17,6 W	166 lm/W	157 lm/W	>80
SLE G7 13mm 3000lm 840 R ADV	28002518	840/359	2,988 lm	2,772 lm	500 mA	31,8 V	37,9 V	17,6 W	170 lm/W	160 lm/W	>80
SLE G7 13mm 3000lm 927 R ADV	28002519	927/359	2,307 lm	2,139 lm	500 mA	31,8 V	37,9 V	17,6 W	131 lm/W	123 lm/W	>90
SLE G7 13mm 3000lm 930 R ADV	28002520	930/359	2,416 lm	2,246 lm	500 mA	31,8 V	37,9 V	17,6 W	137 lm/W	129 lm/W	>90
SLE G7 13mm 3000lm 935 R ADV	28002521	935/359	2,368 lm	2,200 lm	500 mA	31,8 V	37,9 V	17,6 W	135 lm/W	127 lm/W	>90
SLE G7 13mm 3000lm 940 R ADV	28002522	940/359	2,494 lm	2,315 lm	500 mA	31,8 V	37,9 V	17,6 W	142 lm/W	133 lm/W	>90
SLE G7 13mm 3000lm 830 H ADV	28002559	830/359	2,376 lm	2,207 lm	500 mA	31,8 V	37,9 V	17,6 W	135 lm/W	127 lm/W	>80
SLE G7 13mm 3000lm 840 H ADV	28002560	840/359	2,511 lm	2,330 lm	500 mA	31,8 V	37,9 V	17,6 W	143 lm/W	134 lm/W	>80
SLE G7 13mm 3000lm 927 H ADV	28004044	927/359	1,939 lm	1,797 lm	500 mA	31,8 V	37,9 V	17,6 W	110 lm/W	104 lm/W	>90
SLE G7 13mm 3000lm 930 H ADV	28002561	930/359	2,030 lm	1,888 lm	500 mA	31,8 V	37,9 V	17,6 W	115 lm/W	109 lm/W	>90
SLE G7 13mm 3000lm 935 H ADV	28004045	935/359	1,990 lm	1,848 lm	500 mA	31,8 V	37,9 V	17,6 W	113 lm/W	107 lm/W	>90
SLE G7 13mm 3000lm 940 H ADV	28002562	940/359	2,096 lm	1,888 lm	500 mA	31,8 V	37,9 V	17,6 W	119 lm/W	112 lm/W	>90
SLE 13mm 3000lm – Operating mode HO at 900 mA											
SLE G7 13mm 3000lm 827 R ADV	28002515	827/359	-	4,152 lm	900 mA	34,0 V	40,5 V	-	-	124 lm/W	>80
SLE G7 13mm 3000lm 830 R ADV	28002516	830/359	-	4,379 lm	900 mA	34,0 V	40,5 V	-	-	131 lm/W	>80
SLE G7 13mm 3000lm 835 R ADV	28002517	835/359	-	4,513 lm	900 mA	34,0 V	40,5 V	-	-	135 lm/W	>80
SLE G7 13mm 3000lm 840 R ADV	28002518	840/359	-	4,595 lm	900 mA	34,0 V	40,5 V	-	-	138 lm/W	>80
SLE G7 13mm 3000lm 927 R ADV	28002519	927/359	-	3,564 lm	900 mA	34,0 V	40,5 V	-	-	106 lm/W	>90
SLE G7 13mm 3000lm 930 R ADV	28002520	930/359	-	3,744 lm	900 mA	34,0 V	40,5 V	-	-	111 lm/W	>90
SLE G7 13mm 3000lm 935 R ADV	28002521	935/359	-	3,660 lm	900 mA	34,0 V	40,5 V	-	-	109 lm/W	>90
SLE G7 13mm 3000lm 940 R ADV	28002522	840/359	-	3,779 lm	900 mA	34,0 V	40,5 V	-	-	115 lm/W	>90
SLE G7 13mm 3000lm 830 H ADV	28002559	830/359	-	3,680 lm	900 mA	34,0 V	40,5 V	-	-	110 lm/W	>80
SLE G7 13mm 3000lm 840 H ADV	28002560	840/359	-	3,861 lm	900 mA	34,0 V	40,5 V	-	-	116 lm/W	>80
SLE G7 13mm 3000lm 927 H ADV	28004044	927/359	-	2,996 lm	900 mA	34,0 V	40,5 V	-	-	90 lm/W	>90
SLE G7 13mm 3000lm 930 H ADV	28002561	930/359	-	3,146 lm	900 mA	34,0 V	40,5 V	-	-	94 lm/W	>90
SLE G7 13mm 3000lm 935 H ADV	28004045	935/359	-	3,076 lm	900 mA	34,0 V	40,5 V	-	-	92 lm/W	>90
SLE G7 13mm 3000lm 940 H ADV	28002562	940/359	-	3,176 lm	900 mA	34,0 V	40,5 V	-	-	97 lm/W	>90
SLE 15mm 4000lm – Operating mode HE at 500 mA											
SLE G7 15mm 4000lm 827 R ADV	28002523	827/359	-	2,616 lm	500 mA	30,7 V	36,6 V	-	-	157 lm/W	>80
SLE G7 15mm 4000lm 830 R ADV	28002524	830/359	-	2,672 lm	500 mA	30,7 V	36,6 V	-	-	159 lm/W	>80
SLE G7 15mm 4000lm 840 R ADV	28002526	840/359	-	2,404 lm	500 mA	30,7 V	36,6 V	-	-	171 lm/W	>80
SLE G7 15mm 4000lm 927 R ADV	28002527	927/359	-	2,107 lm	500 mA	30,7 V	36,6 V	-	-	126 lm/W	>90

Type	Article number	Photometric code	Useful luminous flux at tp = 25 °C	Expected luminous flux at tp rated	Typ. forward current	Min. forward voltage at tp rated	Max. forward voltage at tp = 25 °C	Power consumption Pon at tp = 25 °C	Efficacy of the module at tp = 25 °C	Expected efficacy of the module at tp rated	Colour rendering index CRI
SLE G7 15mm 4000lm 930 R ADV	28002528	930/359	-	2,251 lm	500 mA	30.7 V	36.6 V	-	-	135 lm/W	>90
SLE G7 15mm 4000lm 940 R ADV	28002530	940/359	-	1,968 lm	500 mA	30.7 V	36.6 V	-	-	140 lm/W	>90
SLE G7 15mm 4000lm 830 H ADV	28002567	830/359	-	2,246 lm	500 mA	30.7 V	36.6 V	-	-	134 lm/W	>80
SLE G7 15mm 4000lm 840 H ADV	28002568	840/359	-	2,404 lm	500 mA	30.7 V	36.6 V	-	-	144 lm/W	>80
SLE G7 15mm 4000lm 930 H ADV	28002569	930/359	-	1,892 lm	500 mA	30.7 V	36.6 V	-	-	114 lm/W	>90
SLE G7 15mm 4000lm 940 H ADV	28002570	940/359	-	1,968 lm	500 mA	30.7 V	36.6 V	-	-	118 lm/W	>90
SLE G7 15mm 4000lm 830 H ADV T	28002670	830/359	-	2,246 lm	500 mA	30.7 V	36.6 V	-	-	134 lm/W	>80
SLE G7 15mm 4000lm 840 H ADV T	28002671	840/359	-	2,404 lm	500 mA	30.7 V	36.6 V	-	-	144 lm/W	>80
SLE G7 15mm 4000lm 930 H ADV T	28002672	930/359	-	1,892 lm	500 mA	30.7 V	36.6 V	-	-	114 lm/W	>90
SLE G7 15mm 4000lm 940 H ADV T	28002673	940/359	-	1,968 lm	500 mA	30.7 V	36.6 V	-	-	118 lm/W	>90
SLE 15mm 4000lm – Operating mode NM at 900 mA											
SLE G7 15mm 4000lm 827 R ADV	28002523	827/359	4,808 lm	4,453 lm	900 mA	32.2 V	38.3 V	32.0 W	150 lm/W	141 lm/W	>80
SLE G7 15mm 4000lm 830 R ADV	28002524	830/359	4,918 lm	4,550 lm	900 mA	32.2 V	38.3 V	32.0 W	154 lm/W	144 lm/W	>80
SLE G7 15mm 4000lm 840 R ADV	28002526	840/359	5,222 lm	4,832 lm	900 mA	32.2 V	38.3 V	32.0 W	163 lm/W	153 lm/W	>80
SLE G7 15mm 4000lm 927 R ADV	28002527	927/359	3,874 lm	3,583 lm	900 mA	32.2 V	38.3 V	32.0 W	121 lm/W	113 lm/W	>90
SLE G7 15mm 4000lm 930 R ADV	28002528	930/359	4,132 lm	3,822 lm	900 mA	32.2 V	38.3 V	32.0 W	129 lm/W	121 lm/W	>90
SLE G7 15mm 4000lm 940 R ADV	28002530	940/359	4,312 lm	3,998 lm	900 mA	32.2 V	38.3 V	32.0 W	135 lm/W	126 lm/W	>90
SLE G7 15mm 4000lm 830 H ADV	28002567	830/359	4,133 lm	3,824 lm	900 mA	32.2 V	38.3 V	32.0 W	129 lm/W	121 lm/W	>80
SLE G7 15mm 4000lm 840 H ADV	28002568	840/359	4,389 lm	4,061 lm	900 mA	32.2 V	38.3 V	32.0 W	137 lm/W	129 lm/W	>80
SLE G7 15mm 4000lm 930 H ADV	28002569	930/359	3,473 lm	3,212 lm	900 mA	32.2 V	38.3 V	32.0 W	109 lm/W	102 lm/W	>90
SLE G7 15mm 4000lm 940 H ADV	28002570	940/359	3,624 lm	3,360 lm	900 mA	32.2 V	38.3 V	32.0 W	113 lm/W	106 lm/W	>90
SLE G7 15mm 4000lm 830 H ADV T	28002670	830/359	4,133 lm	3,824 lm	900 mA	32.2 V	38.3 V	32.0 W	129 lm/W	121 lm/W	>80
SLE G7 15mm 4000lm 840 H ADV T	28002671	840/359	4,389 lm	4,061 lm	900 mA	32.2 V	38.3 V	32.0 W	137 lm/W	129 lm/W	>80
SLE G7 15mm 4000lm 930 H ADV T	28002672	930/359	3,473 lm	3,212 lm	900 mA	32.2 V	38.3 V	32.0 W	109 lm/W	102 lm/W	>90
SLE G7 15mm 4000lm 940 H ADV T	28002673	940/359	3,624 lm	3,360 lm	900 mA	32.2 V	38.3 V	32.0 W	113 lm/W	106 lm/W	>90
SLE 15mm 4000lm – Operating mode HO at 1,200 mA											
SLE G7 15mm 4000lm 827 R ADV	28002523	827/359	-	5,716 lm	1,200 mA	33.2 V	39.5 V	-	-	132 lm/W	>80
SLE G7 15mm 4000lm 830 R ADV	28002524	830/359	-	5,838 lm	1,200 mA	33.2 V	39.5 V	-	-	134 lm/W	>80
SLE G7 15mm 4000lm 840 R ADV	28002526	840/359	-	6,182 lm	1,200 mA	33.2 V	39.5 V	-	-	143 lm/W	>90
SLE G7 15mm 4000lm 927 R ADV	28002527	927/359	-	4,592 lm	1,200 mA	33.2 V	39.5 V	-	-	106 lm/W	>90
SLE G7 15mm 4000lm 930 R ADV	28002528	930/359	-	4,902 lm	1,200 mA	33.2 V	39.5 V	-	-	113 lm/W	>90
SLE G7 15mm 4000lm 940 R ADV	28002530	940/359	-	5,131 lm	1,200 mA	33.2 V	39.5 V	-	-	118 lm/W	>90
SLE G7 15mm 4000lm 830 H ADV	28002567	830/359	-	4,906 lm	1,200 mA	32.2 V	39.5 V	-	-	113 lm/W	>80
SLE G7 15mm 4000lm 840 H ADV	28002568	840/359	-	5,196 lm	1,200 mA	32.2 V	39.5 V	-	-	120 lm/W	>80
SLE G7 15mm 4000lm 930 H ADV	28002569	930/359	-	4,120 lm	1,200 mA	32.2 V	39.5 V	-	-	95 lm/W	>90
SLE G7 15mm 4000lm 940 H ADV	28002570	940/359	-	4,312 lm	1,200 mA	32.2 V	39.5 V	-	-	99 lm/W	>90
SLE G7 15mm 4000lm 830 H ADV T	28002670	830/359	-	4,906 lm	1,200 mA	32.2 V	39.5 V	-	-	113 lm/W	>80
SLE G7 15mm 4000lm 840 H ADV T	28002671	840/359	-	5,196 lm	1,200 mA	32.2 V	39.5 V	-	-	120 lm/W	>80
SLE G7 15mm 4000lm 930 H ADV T	28002672	930/359	-	4,120 lm	1,200 mA	32.2 V	39.5 V	-	-	95 lm/W	>90
SLE G7 15mm 4000lm 940 H ADV T	28002673	940/359	-	4,312 lm	1,200 mA	32.2 V	39.5 V	-	-	99 lm/W	>90
SLE 17mm 5000lm – Operating mode HE at 500 mA											
SLE G7 17mm 5000lm 827 R ADV	28002588	827/359	-	2,615 lm	500 mA	30.6 V	36.7 V	-	-	153 lm/W	>80
SLE G7 17mm 5000lm 830 R ADV	28002589	830/359	-	2,816 lm	500 mA	30.6 V	36.7 V	-	-	168 lm/W	>80
SLE G7 17mm 5000lm 835 R ADV	28002590	835/359	-	2,829 lm	500 mA	30.6 V	36.7 V	-	-	170 lm/W	>80
SLE G7 17mm 5000lm 840 R ADV	28002591	840/359	-	2,971 lm	500 mA	30.6 V	36.7 V	-	-	178 lm/W	>80
SLE G7 17mm 5000lm 927 R ADV	28002592	927/359	-	2,225 lm	500 mA	30.6 V	36.7 V	-	-	134 lm/W	>90
SLE G7 17mm 5000lm 930 R ADV	28002593	930/359	-	2,449 lm	500 mA	30.6 V	36.7 V	-	-	147 lm/W	>90
SLE G7 17mm 5000lm 935 R ADV	28002594	935/359	-	2,474 lm	500 mA	30.6 V	36.7 V	-	-	149 lm/W	>90
SLE G7 17mm 5000lm 940 R ADV	28002595	940/359	-	2,536 lm	500 mA	30.6 V	36.7 V	-	-	152 lm/W	>90
SLE G7 17mm 5000lm 827 H ADV	28002612	827/359	-	2,197 lm	500 mA	30.6 V	36.7 V	-	-	129 lm/W	>80
SLE G7 17mm 5000lm 830 H ADV	28002613	830/359	-	2,367 lm	500 mA	30.6 V	36.7 V	-	-	142 lm/W	>80
SLE G7 17mm 5000lm 835 H ADV	28002614	835/359	-	2,377 lm	500 mA	30.6 V	36.7 V	-	-	143 lm/W	>80
SLE G7 17mm 5000lm 840 H ADV	28002615	840/359	-	2,497 lm	500 mA	30.6 V	36.7 V	-	-	150 lm/W	>80
SLE G7 17mm 5000lm 927 H ADV	28002616	927/359	-	1,870 lm	500 mA	30.6 V	36.7 V	-	-	112 lm/W	>90
SLE G7 17mm 5000lm 930 H ADV	28002617	930/359	-	2,058 lm	500 mA	30.6 V	36.7 V	-	-	123 lm/W	>90
SLE G7 17mm 5000lm 935 H ADV	28002618	935/359	-	2,079 lm	500 mA	30.6 V	36.7 V	-	-	125 lm/W	>90
SLE G7 17mm 5000lm 940 H ADV	28002619	940/359	-	2,131 lm	500 mA	30.6 V	36.7 V	-	-	128 lm/W	>90
SLE G7 17mm 5000lm 830 H ADV T	28002620	830/359	-	2,367 lm	500 mA	30.6 V	36.7 V	-	-	142 lm/W	>80
SLE G7 17mm 5000lm 840 H ADV T	28002621	840/359	-	2,497 lm	500 mA	30.6 V	36.7 V	-	-	150 lm/W	>80
SLE G7 17mm 5000lm 930 H ADV T	28002622	930/359	-	2,058 lm	500 mA	30.6 V	36.7 V	-	-	123 lm/W	>90
SLE G7 17mm 5000lm 935 H ADV T	28002623	935/359	-	2,079 lm	500 mA	30.6 V	36.7 V	-	-	125 lm/W	>90
SLE G7 17mm 5000lm 940 H ADV T	28002624	940/359	-	2,131 lm	500 mA	30.6 V	36.7 V	-	-	128 lm/W	>90
SLE 17mm 5000lm – Operating mode NM at 1,050 mA											
SLE G7 17mm 5000lm 827 R ADV	28002588	827/359	5,541 lm	5,154 lm	1,050 mA	32.0 V	38.3 V	37.3 W	149 lm/W	144 lm/W	>80
SLE G7 17mm 5000lm 830 R ADV	28002589	830/359	5,954 lm	5,545 lm	1,050 mA	32.0 V	38.3 V	37.3 W	160 lm/W	152 lm/W	>80
SLE G7 17mm 5000lm 835 R ADV	28002590	835/359	5,984 lm	5,572 lm	1,050 mA	32.0 V	38.3 V	37.3 W	160 lm/W	153 lm/W	>80
SLE G7 17mm 5000lm 840 R ADV	28002591	840/359	6,288 lm	5,854 lm	1,050 mA	32.0 V	38.3 V	37.3 W	169 lm/W	160 lm/W	>80
SLE G7 17mm 5000lm 927 R ADV	28002592	927/359	4,702 lm	4,373 lm	1,050 mA	32.0 V	38.3 V	37.3 W	126 lm/W	120 lm/W	>90
SLE G7 17mm 5000lm 930 R ADV	28002593	930/359	5,178 lm	4,818 lm	1,050 mA	32.0 V	38.3 V	37.3 W	139 lm/W	132 lm/W	>90

Type	Article number	Photometric code	Useful luminous flux at tp = 25 °C	Expected luminous flux at tp rated	Typ. forward current	Min. forward voltage at tp rated	Max. forward voltage at tp = 25 °C	Power consumption Pon at tp = 25 °C	Efficacy of the module at tp = 25 °C	Expected efficacy of the module at tp rated	Colour rendering index CRI
SLE G7 17mm 5000lm 935 R ADV	28002594	935/359	5,248 lm	4,879 lm	1,050 mA	32.0 V	38.3 V	37.3 W	141 lm/W	134 lm/W	>90
SLE G7 17mm 5000lm 940 R ADV	28002595	940/359	5,368 lm	4,993 lm	1,050 mA	32.0 V	38.3 V	37.3 W	144 lm/W	137 lm/W	>90
SLE G7 17mm 5000lm 827 H ADV	28002612	827/359	4,657 lm	4,331 lm	1,050 mA	32.0 V	38.3 V	37.3 W	125 lm/W	121 lm/W	>80
SLE G7 17mm 5000lm 830 H ADV	28002613	830/359	5,004 lm	4,660 lm	1,050 mA	32.0 V	38.3 V	37.3 W	134 lm/W	128 lm/W	>80
SLE G7 17mm 5000lm 835 H ADV	28002614	835/359	5,029 lm	4,682 lm	1,050 mA	32.0 V	38.3 V	37.3 W	135 lm/W	128 lm/W	>80
SLE G7 17mm 5000lm 840 H ADV	28002615	840/359	5,284 lm	4,919 lm	1,050 mA	32.0 V	38.3 V	37.3 W	142 lm/W	134 lm/W	>80
SLE G7 17mm 5000lm 927 H ADV	28002616	927/359	3,952 lm	3,675 lm	1,050 mA	32.0 V	38.3 V	37.3 W	106 lm/W	101 lm/W	>90
SLE G7 17mm 5000lm 930 H ADV	28002617	930/359	4,352 lm	4,049 lm	1,050 mA	32.0 V	38.3 V	37.3 W	117 lm/W	111 lm/W	>90
SLE G7 17mm 5000lm 935 H ADV	28002618	935/359	4,410 lm	4,100 lm	1,050 mA	32.0 V	38.3 V	37.3 W	118 lm/W	112 lm/W	>90
SLE G7 17mm 5000lm 940 H ADV	28002619	940/359	4,511 lm	4,196 lm	1,050 mA	32.0 V	38.3 V	37.3 W	121 lm/W	115 lm/W	>90
SLE G7 17mm 5000lm 830 H ADV T	28002620	830/359	5,004 lm	4,660 lm	1,050 mA	32.0 V	38.3 V	37.3 W	134 lm/W	128 lm/W	>80
SLE G7 17mm 5000lm 840 H ADV T	28002621	840/359	5,284 lm	4,919 lm	1,050 mA	32.0 V	38.3 V	37.3 W	142 lm/W	134 lm/W	>80
SLE G7 17mm 5000lm 930 H ADV T	28002622	930/359	4,352 lm	4,049 lm	1,050 mA	32.0 V	38.3 V	37.3 W	117 lm/W	111 lm/W	>90
SLE G7 17mm 5000lm 935 H ADV T	28002623	935/359	4,410 lm	4,100 lm	1,050 mA	32.0 V	38.3 V	37.3 W	118 lm/W	112 lm/W	>90
SLE G7 17mm 5000lm 940 H ADV T	28002624	940/359	4,511 lm	4,196 lm	1,050 mA	32.0 V	38.3 V	37.3 W	121 lm/W	115 lm/W	>90
SLE 17mm 5000lm – Operating mode HO at 1,400 mA											
SLE G7 17mm 5000lm 827 R ADV	28002588	827/359	-	6,636 lm	1,400 mA	32.7 V	39.2 V	-	-	125 lm/W	>80
SLE G7 17mm 5000lm 830 R ADV	28002589	830/359	-	7,133 lm	1,400 mA	32.7 V	39.2 V	-	-	143 lm/W	>80
SLE G7 17mm 5000lm 835 R ADV	28002590	835/359	-	7,173 lm	1,400 mA	32.7 V	39.2 V	-	-	144 lm/W	>80
SLE G7 17mm 5000lm 840 R ADV	28002591	840/359	-	7,532 lm	1,400 mA	32.7 V	39.2 V	-	-	151 lm/W	>80
SLE G7 17mm 5000lm 927 R ADV	28002592	927/359	-	5,631 lm	1,400 mA	32.7 V	39.2 V	-	-	113 lm/W	>90
SLE G7 17mm 5000lm 930 R ADV	28002593	930/359	-	6,198 lm	1,400 mA	32.7 V	39.2 V	-	-	125 lm/W	>90
SLE G7 17mm 5000lm 935 R ADV	28002594	935/359	-	6,286 lm	1,400 mA	32.7 V	39.2 V	-	-	126 lm/W	>90
SLE G7 17mm 5000lm 940 R ADV	28002595	940/359	-	6,434 lm	1,400 mA	32.7 V	39.2 V	-	-	129 lm/W	>90
SLE G7 17mm 5000lm 827 H ADV	28002612	827/359	-	5,577 lm	1,400 mA	32.7 V	39.2 V	-	-	105 lm/W	>80
SLE G7 17mm 5000lm 830 H ADV	28002613	830/359	-	5,995 lm	1,400 mA	32.7 V	39.2 V	-	-	120 lm/W	>80
SLE G7 17mm 5000lm 835 H ADV	28002614	835/359	-	6,028 lm	1,400 mA	32.7 V	39.2 V	-	-	121 lm/W	>80
SLE G7 17mm 5000lm 840 H ADV	28002615	840/359	-	6,330 lm	1,400 mA	32.7 V	39.2 V	-	-	127 lm/W	>80
SLE G7 17mm 5000lm 927 H ADV	28002616	927/359	-	4,732 lm	1,400 mA	32.7 V	39.2 V	-	-	95 lm/W	>90
SLE G7 17mm 5000lm 930 H ADV	28002617	930/359	-	5,208 lm	1,400 mA	32.7 V	39.2 V	-	-	105 lm/W	>90
SLE G7 17mm 5000lm 935 H ADV	28002618	935/359	-	5,282 lm	1,400 mA	32.7 V	39.2 V	-	-	106 lm/W	>90
SLE G7 17mm 5000lm 940 H ADV	28002619	940/359	-	5,407 lm	1,400 mA	32.7 V	39.2 V	-	-	109 lm/W	>90
SLE G7 17mm 5000lm 830 H ADV T	28002620	830/359	-	5,995 lm	1,400 mA	32.7 V	39.2 V	-	-	120 lm/W	>80
SLE G7 17mm 5000lm 840 H ADV T	28002621	840/359	-	6,330 lm	1,400 mA	32.7 V	39.2 V	-	-	127 lm/W	>80
SLE G7 17mm 5000lm 930 H ADV T	28002622	930/359	-	5,208 lm	1,400 mA	32.7 V	39.2 V	-	-	105 lm/W	>90
SLE G7 17mm 5000lm 935 H ADV T	28002623	935/359	-	5,282 lm	1,400 mA	32.7 V	39.2 V	-	-	106 lm/W	>90
SLE G7 17mm 5000lm 940 H ADV T	28002624	940/359	-	5,407 lm	1,400 mA	32.7 V	39.2 V	-	-	109 lm/W	>90
SLE 21mm 6000lm – Operating mode HE at 700 mA											
SLE G7 21mm 6000lm 827 R ADV	28002596	827/359	-	3,756 lm	700 mA	30.6 V	36.7 V	-	-	160 lm/W	>80
SLE G7 21mm 6000lm 830 R ADV	28002597	830/359	-	4,002 lm	700 mA	30.6 V	36.7 V	-	-	172 lm/W	>80
SLE G7 21mm 6000lm 840 R ADV	28002599	840/359	-	4,207 lm	700 mA	30.6 V	36.7 V	-	-	180 lm/W	>80
SLE G7 21mm 6000lm 927 R ADV	28002600	927/359	-	3,125 lm	700 mA	30.6 V	36.7 V	-	-	134 lm/W	>90
SLE G7 21mm 6000lm 930 R ADV	28002601	930/359	-	3,441 lm	700 mA	30.6 V	36.7 V	-	-	147 lm/W	>90
SLE G7 21mm 6000lm 940 R ADV	28002603	940/359	-	3,596 lm	700 mA	30.6 V	36.7 V	-	-	154 lm/W	>90
SLE G7 21mm 6000lm 827 H ADV	28002631	827/359	-	3,156 lm	700 mA	30.6 V	36.7 V	-	-	135 lm/W	>80
SLE G7 21mm 6000lm 830 H ADV	28002632	830/359	-	3,363 lm	700 mA	30.6 V	36.7 V	-	-	144 lm/W	>80
SLE G7 21mm 6000lm 840 H ADV	28002633	840/359	-	3,536 lm	700 mA	30.6 V	36.7 V	-	-	152 lm/W	>80
SLE G7 21mm 6000lm 927 H ADV	28002634	927/359	-	2,627 lm	700 mA	30.6 V	36.7 V	-	-	113 lm/W	>90
SLE G7 21mm 6000lm 930 H ADV	28002635	930/359	-	2,892 lm	700 mA	30.6 V	36.7 V	-	-	123 lm/W	>90
SLE G7 21mm 6000lm 940 H ADV	28002637	940/359	-	3,022 lm	700 mA	30.6 V	36.7 V	-	-	130 lm/W	>90
SLE G7 21mm 6000lm 830 H ADV T	28002638	830/359	-	3,363 lm	700 mA	30.6 V	36.7 V	-	-	144 lm/W	>80
SLE G7 21mm 6000lm 840 H ADV T	28002639	840/359	-	3,536 lm	700 mA	30.6 V	36.7 V	-	-	152 lm/W	>80
SLE G7 21mm 6000lm 930 H ADV T	28002640	930/359	-	2,892 lm	700 mA	30.6 V	36.7 V	-	-	123 lm/W	>90
SLE G7 21mm 6000lm 940 H ADV T	28002641	940/359	-	3,022 lm	700 mA	30.6 V	36.7 V	-	-	130 lm/W	>90
SLE 21mm 6000lm – Operating mode NM at 1,400 mA											
SLE G7 21mm 6000lm 827 R ADV	28002596	827/359	7,626 lm	7,089 lm	1,400 mA	31.9 V	38.2 V	49.6 W	154 lm/W	145 lm/W	>80
SLE G7 21mm 6000lm 830 R ADV	28002597	830/359	8,132 lm	7,563 lm	1,400 mA	31.9 V	38.2 V	49.6 W	164 lm/W	156 lm/W	>80
SLE G7 21mm 6000lm 840 R ADV	28002599	840/359	8,553 lm	7,959 lm	1,400 mA	31.9 V	38.2 V	49.6 W	172 lm/W	164 lm/W	>80
SLE G7 21mm 6000lm 927 R ADV	28002600	927/359	6,357 lm	5,913 lm	1,400 mA	31.9 V	38.2 V	49.6 W	128 lm/W	121 lm/W	>90
SLE G7 21mm 6000lm 930 R ADV	28002601	930/359	6,981 lm	6,494 lm	1,400 mA	31.9 V	38.2 V	49.6 W	141 lm/W	133 lm/W	>90
SLE G7 21mm 6000lm 940 R ADV	28002603	940/359	7,311 lm	6,796 lm	1,400 mA	31.9 V	38.2 V	49.6 W	147 lm/W	139 lm/W	>90
SLE G7 21mm 6000lm 827 H ADV	28002631	827/359	6,409 lm	5,958 lm	1,400 mA	31.9 V	38.2 V	49.6 W	129 lm/W	122 lm/W	>80
SLE G7 21mm 6000lm 830 H ADV	28002632	830/359	6,834 lm	6,356 lm	1,400 mA	31.9 V	38.2 V	49.6 W	138 lm/W	131 lm/W	>80
SLE G7 21mm 6000lm 840 H ADV	28002633	840/359	7,188 lm	6,689 lm	1,400 mA	31.9 V	38.2 V	49.6 W	145 lm/W	137 lm/W	>80
SLE G7 21mm 6000lm 927 H ADV	28002634	927/359	5,342 lm	4,970 lm	1,400 mA	31.9 V	38.2 V	49.6 W	108 lm/W	102 lm/W	>90
SLE G7 21mm 6000lm 930 H ADV	28002635	930/359	5,867 lm	5,457 lm	1,400 mA	31.9 V	38.2 V	49.6 W	118 lm/W	112 lm/W	>90
SLE G7 21mm 6000lm 940 H ADV	28002637	940/359	6,144 lm	5,711 lm	1,400 mA	31.9 V	38.2 V	49.6 W	124 lm/W	117 lm/W	>90
SLE G7 21mm 6000lm 830 H ADV T	28002638	830/359	6,834 lm	6,356 lm	1,400 mA	31.9 V	38.2 V	49.6 W	138 lm/W	131 lm/W	>80
SLE G7 21mm 6000lm 840 H ADV T	28002639	840/359	7,188 lm	6,689 lm	1,400 mA	31.9 V	38.2 V	49.6 W	145 lm/W	137 lm/W	>80

Type	Article number	Photometric code	Useful luminous flux at $t_p = 25^\circ\text{C}$	Expected luminous flux at t_p rated	Typ. forward current	Min. forward voltage at t_p rated	Max. forward voltage at $t_p = 25^\circ\text{C}$	Power consumption P_{on} at $t_p = 25^\circ\text{C}$	Efficacy of the module at $t_p = 25^\circ\text{C}$	Expected efficacy of the module at t_p rated	Colour rendering index CRI
SLE G7 21mm 6000lm 930 H ADV T	28002640	930/359	5,867 lm	5,457 lm	1,400 mA	31.9 V	38.2 V	49.6 W	118 lm/W	112 lm/W	>90
SLE G7 21mm 6000lm 940 H ADV T	28002641	940/359	6,144 lm	5,711 lm	1,400 mA	31.9 V	38.2 V	49.6 W	124 lm/W	117 lm/W	>90
SLE 21mm 6000lm – Operating mode HO at 2,000 mA											
SLE G7 21mm 6000lm 827 R ADV	28002596	827/359	-	9,695 lm	2,000 mA	32.8 V	39.3 V	-	-	136 lm/W	>80
SLE G7 21mm 6000lm 830 R ADV	28002597	830/359	-	10,339 lm	2,000 mA	32.8 V	39.3 V	-	-	145 lm/W	>80
SLE G7 21mm 6000lm 840 R ADV	28002599	840/359	-	10,879 lm	2,000 mA	32.8 V	39.3 V	-	-	153 lm/W	>80
SLE G7 21mm 6000lm 927 R ADV	28002600	927/359	-	8,084 lm	2,000 mA	32.8 V	39.3 V	-	-	113 lm/W	>90
SLE G7 21mm 6000lm 930 R ADV	28002601	930/359	-	8,880 lm	2,000 mA	32.8 V	39.3 V	-	-	124 lm/W	>90
SLE G7 21mm 6000lm 940 R ADV	28002603	940/359	-	9,292 lm	2,000 mA	32.8 V	39.3 V	-	-	130 lm/W	>90
SLE G7 21mm 6000lm 827 H ADV	28002631	827/359	-	8,148 lm	2,000 mA	32.8 V	39.3 V	-	-	114 lm/W	>80
SLE G7 21mm 6000lm 830 H ADV	28002632	830/359	-	8,689 lm	2,000 mA	32.8 V	39.3 V	-	-	122 lm/W	>80
SLE G7 21mm 6000lm 840 H ADV	28002633	840/359	-	9,143 lm	2,000 mA	32.8 V	39.3 V	-	-	128 lm/W	>80
SLE G7 21mm 6000lm 927 H ADV	28002634	927/359	-	6,794 lm	2,000 mA	32.8 V	39.3 V	-	-	95 lm/W	>90
SLE G7 21mm 6000lm 930 H ADV	28002635	930/359	-	7,463 lm	2,000 mA	32.8 V	39.3 V	-	-	104 lm/W	>90
SLE G7 21mm 6000lm 940 H ADV	28002637	940/359	-	7,809 lm	2,000 mA	32.8 V	39.3 V	-	-	109 lm/W	>90
SLE G7 21mm 6000lm 830 H ADV T	28002638	830/359	-	8,689 lm	2,000 mA	32.8 V	39.3 V	-	-	122 lm/W	>80
SLE G7 21mm 6000lm 840 H ADV T	28002639	840/359	-	9,143 lm	2,000 mA	32.8 V	39.3 V	-	-	128 lm/W	>80
SLE G7 21mm 6000lm 930 H ADV T	28002640	930/359	-	7,463 lm	2,000 mA	32.8 V	39.3 V	-	-	104 lm/W	>90
SLE G7 21mm 6000lm 940 H ADV T	28002641	940/359	-	7,809 lm	2,000 mA	32.8 V	39.3 V	-	-	109 lm/W	>90

① See derating curves in data sheet section 2.3.

② The detailed explanation, see data sheet section 3.1.

③ Tolerance of useful light flux - 0 % / + 15 %. Measurement uncertainty $\pm 10\%$.

④ Tolerance of expected light flux - 0 % / + 15 %. Measurement uncertainty $\pm 10\%$. Based on calculation.

⑤ Tolerance of power consumption $P_{on} \pm 10\%$. Measurement uncertainty $\pm 5\%$.

Housing for SLE

Accessory

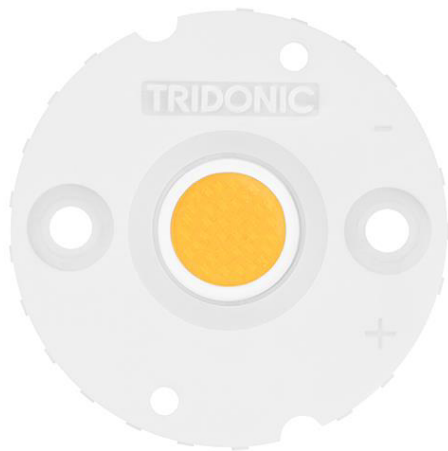

Product description

- _ Housing for SLE
- _ Diameter: 35 mm
- _ Material: Lexan Resin 943
- _ M3 screws with flat head, max. head diameter of 6 mm and max. torque for fixing is 0.5 Nm

Website

<http://www.tridonic.com/28003024>



LES09

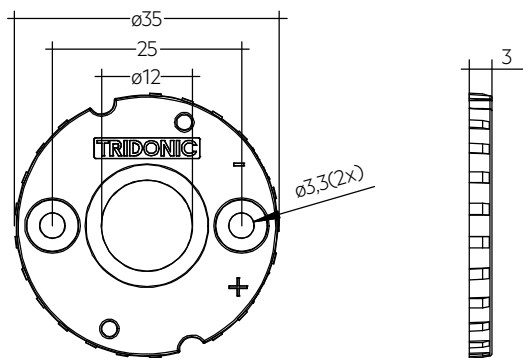

SLE G7 HOUSING LES09

Ordering data

Type	Article number	Packaging, bag	Weight per pc.
SLE G7 HOUSING LES 09	28003024	500 pc(s).	0.002 kg
SLE G7 HOUSING LES 13/15	28003026	500 pc(s).	0.002 kg

1. Standards

EN 62031
 EN 62471
 IEC 62717
 IEC 61000-4-2
 UL 8750 (for CLASS2 circuits and dry locations)

1.1 Glow wire test for housing variants

according to IEC 60695-2-11 with increased temperature of 850 °C passed.

1.2 Photometric code

Key for photometric code, e. g. 830 / 359

1 st digit	2 nd + 3 rd digit	4 th digit	5 th digit	6 th digit
Code CRI	Colour temperature in Kelvin x 100	MacAdam initial	MacAdam after 25% of the lifetime (max.6000h)	Luminous flux after 25% of the lifetime (max.6000h)
7 70 – 79				Code Luminous flux
8 80 – 89				7 ≥ 70 %
9 ≥90				8 ≥ 80 %
				9 ≥ 90 %

1.3 Energy classification

Type	Colour temperature	Forward current	Energy classification	Energy consumption
SLE G7 09mm – Without housing				
SLE G7 09mm 1200lm 830 R ADV	3,100 K	350 mA	D	13 kWh / 1,000 h
SLE G7 09mm 1200lm 840 R ADV	4,100 K	350 mA	D	13 kWh / 1,000 h
SLE G7 09mm 1200lm 927 R ADV	2,700 K	350 mA	E	13 kWh / 1,000 h
SLE G7 09mm 1200lm 930 R ADV	3,100 K	350 mA	E	13 kWh / 1,000 h
SLE G7 09mm 1200lm 940 R ADV	4,100 K	350 mA	E	13 kWh / 1,000 h
SLE G7 13mm – Without housing				
SLE G7 13mm 3000lm 827 R ADV	2,700 K	500 mA	D	18 kWh / 1,000 h
SLE G7 13mm 3000lm 830 R ADV	3,100 K	500 mA	D	18 kWh / 1,000 h
SLE G7 13mm 3000lm 835 R ADV	3,500 K	500 mA	D	18 kWh / 1,000 h
SLE G7 13mm 3000lm 840 R ADV	4,100 K	500 mA	D	18 kWh / 1,000 h
SLE G7 13mm 3000lm 927 R ADV	2,700 K	500 mA	E	18 kWh / 1,000 h
SLE G7 13mm 3000lm 930 R ADV	3,100 K	500 mA	E	18 kWh / 1,000 h
SLE G7 13mm 3000lm 935 R ADV	3,500 K	500 mA	E	18 kWh / 1,000 h
SLE G7 13mm 3000lm 940 R ADV	4,100 K	500 mA	E	18 kWh / 1,000 h
SLE G7 15mm – Without housing				
SLE G7 15mm 4000lm 827 R ADV	2,700 K	900 mA	D	32 kWh / 1,000 h
SLE G7 15mm 4000lm 830 R ADV	3,100 K	900 mA	D	32 kWh / 1,000 h
SLE G7 15mm 4000lm 840 R ADV	4,100 K	900 mA	D	32 kWh / 1,000 h
SLE G7 15mm 4000lm 927 R ADV	2,700 K	900 mA	E	32 kWh / 1,000 h
SLE G7 15mm 4000lm 930 R ADV	3,100 K	900 mA	E	32 kWh / 1,000 h
SLE G7 15mm 4000lm 940 R ADV	4,100 K	900 mA	E	32 kWh / 1,000 h
SLE G7 17mm – Without housing				
SLE G7 17mm 5000lm 827 R ADV	2,700 K	1,050 mA	D	38 kWh / 1,000 h
SLE G7 17mm 5000lm 830 R ADV	3,100 K	1,050 mA	D	38 kWh / 1,000 h
SLE G7 17mm 5000lm 835 R ADV	3,500 K	1,050 mA	D	38 kWh / 1,000 h
SLE G7 17mm 5000lm 840 R ADV	4,100 K	1,050 mA	D	38 kWh / 1,000 h
SLE G7 17mm 5000lm 927 R ADV	2,700 K	1,050 mA	E	38 kWh / 1,000 h
SLE G7 17mm 5000lm 930 R ADV	3,100 K	1,050 mA	E	38 kWh / 1,000 h
SLE G7 17mm 5000lm 935 R ADV	3,500 K	1,050 mA	E	38 kWh / 1,000 h
SLE G7 17mm 5000lm 940 R ADV	4,100 K	1,050 mA	E	38 kWh / 1,000 h

Type	Colour temperature	Forward current	Energy classification	Energy consumption
SLE G7 21mm – Without housing				
SLE G7 21mm 6000lm 827 R ADV	2,700 K	1,400 mA	D	50 kWh / 1,000 h
SLE G7 21mm 6000lm 830 R ADV	3,100 K	1,400 mA	D	50 kWh / 1,000 h
SLE G7 21mm 6000lm 840 R ADV	4,100 K	1,400 mA	D	50 kWh / 1,000 h
SLE G7 21mm 6000lm 927 R ADV	2,700 K	1,400 mA	E	50 kWh / 1,000 h
SLE G7 21mm 6000lm 930 R ADV	3,100 K	1,400 mA	E	50 kWh / 1,000 h
SLE G7 21mm 6000lm 940 R ADV	4,100 K	1,400 mA	D	50 kWh / 1,000 h
SLE G7 13mm – With housing				
SLE G7 13mm 3000lm 830 H ADV	3,100 K	500 mA	D	18 kWh / 1,000 h
SLE G7 13mm 3000lm 840 H ADV	4,100 K	500 mA	D	18 kWh / 1,000 h
SLE G7 13mm 3000lm 927 H ADV	2,700 K	500 mA	E	18 kWh / 1,000 h
SLE G7 13mm 3000lm 930 H ADV	3,100 K	500 mA	E	18 kWh / 1,000 h
SLE G7 13mm 3000lm 935 H ADV	3,500 K	500 mA	E	18 kWh / 1,000 h
SLE G7 13mm 3000lm 940 H ADV	4,100 K	500 mA	E	18 kWh / 1,000 h
SLE G7 15mm – With housing				
SLE G7 15mm 4000lm 830 H ADV	3,100 K	900 mA	D	32 kWh / 1,000 h
SLE G7 15mm 4000lm 840 H ADV	4,100 K	900 mA	D	32 kWh / 1,000 h
SLE G7 15mm 4000lm 930 H ADV	3,100 K	900 mA	E	32 kWh / 1,000 h
SLE G7 15mm 4000lm 940 H ADV	4,100 K	900 mA	E	32 kWh / 1,000 h
SLE G7 17mm – With housing				
SLE G7 17mm 5000lm 827 H ADV	2,700 K	1,050 mA	D	38 kWh / 1,000 h
SLE G7 17mm 5000lm 830 H ADV	3,100 K	1,050 mA	D	38 kWh / 1,000 h
SLE G7 17mm 5000lm 835 H ADV	3,500 K	1,050 mA	D	38 kWh / 1,000 h
SLE G7 17mm 5000lm 840 H ADV	4,100 K	1,050 mA	D	38 kWh / 1,000 h
SLE G7 17mm 5000lm 927 H ADV	2,700 K	1,050 mA	E	38 kWh / 1,000 h
SLE G7 17mm 5000lm 930 H ADV	3,100 K	1,050 mA	E	38 kWh / 1,000 h
SLE G7 17mm 5000lm 935 H ADV	3,500 K	1,050 mA	E	38 kWh / 1,000 h
SLE G7 17mm 5000lm 940 H ADV	4,100 K	1,050 mA	E	38 kWh / 1,000 h
SLE G7 21mm – With housing				
SLE G7 21mm 6000lm 827 H ADV	2,700 K	1,400 mA	D	50 kWh / 1,000 h
SLE G7 21mm 6000lm 830 H ADV	3,100 K	1,400 mA	D	50 kWh / 1,000 h
SLE G7 21mm 6000lm 840 H ADV	4,100 K	1,400 mA	D	50 kWh / 1,000 h
SLE G7 21mm 6000lm 927 H ADV	2,700 K	1,400 mA	E	50 kWh / 1,000 h
SLE G7 21mm 6000lm 930 H ADV	3,100 K	1,400 mA	E	50 kWh / 1,000 h
SLE G7 21mm 6000lm 940 H ADV	4,100 K	1,400 mA	E	50 kWh / 1,000 h
SLE G7 15mm – With housing and thermal interface material				
SLE G7 15mm 4000lm 830 H ADV T	3,100 K	900 mA	D	32 kWh / 1,000 h
SLE G7 15mm 4000lm 840 H ADV T	4,100 K	900 mA	D	32 kWh / 1,000 h
SLE G7 15mm 4000lm 930 H ADV T	3,100 K	900 mA	E	32 kWh / 1,000 h
SLE G7 15mm 4000lm 940 H ADV T	4,100 K	900 mA	E	32 kWh / 1,000 h
SLE G7 17mm – With housing and thermal interface material				
SLE G7 17mm 5000lm 830 H ADV T	3,100 K	1,050 mA	D	38 kWh / 1,000 h
SLE G7 17mm 5000lm 840 H ADV T	4,100 K	1,050 mA	D	38 kWh / 1,000 h
SLE G7 17mm 5000lm 930 H ADV T	3,100 K	1,050 mA	E	38 kWh / 1,000 h
SLE G7 17mm 5000lm 935 H ADV T	3,500 K	1,050 mA	E	38 kWh / 1,000 h
SLE G7 17mm 5000lm 940 H ADV T	4,100 K	1,050 mA	E	38 kWh / 1,000 h
SLE G7 21mm – With housing and thermal interface material				
SLE G7 21mm 6000lm 830 H ADV T	3,100 K	1,400 mA	D	50 kWh / 1,000 h
SLE G7 21mm 6000lm 840 H ADV T	4,100 K	1,400 mA	D	50 kWh / 1,000 h
SLE G7 21mm 6000lm 930 H ADV T	3,100 K	1,400 mA	E	50 kWh / 1,000 h
SLE G7 21mm 6000lm 940 H ADV T	4,100 K	1,400 mA	E	50 kWh / 1,000 h

Energy label and further information at www.tridonic.com in the certificates tab of the corresponding product page and at the EPREL data base <https://eprel.ec.europa.eu/>

2. Thermal details

2.1 tp point, ambient temperature and lifetime

The temperature at tp reference point is crucial for the light output and lifetime of a LED product.

For SLE G7 a tp temperature of 65°C has to be complied in order to achieve an optimum between heat sink requirements, light output and lifetime.

Compliance with the maximum permissible reference temperature at the tp point must be checked under operating conditions in a thermally stable state. The maximum value must be determined under worst-case conditions for the relevant application.

The tc and tp temperature of LED modules from Tridonic are measured at the same reference point.

To check the tc / tp temperature, the temperature sensor has to be mounted on the PCB at the marked position as stated in the drawing.

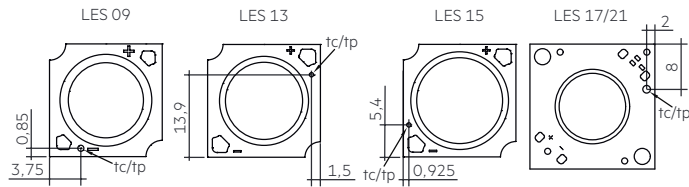

2.2 Storage and humidity

storage temperature	-30...+80 °C
---------------------	--------------

Operation only in non condensing environment. Humidity during processing of the module should be between 0 to 85 %.

2.3 Derating curves

SLE G7 09mm 1200lm xx0 advanced

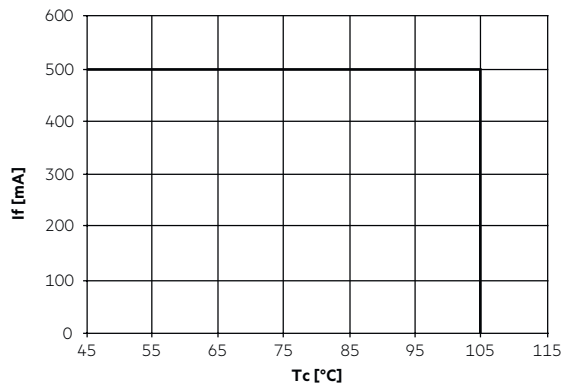

SLE G7 13mm 3000lm xx0 advanced

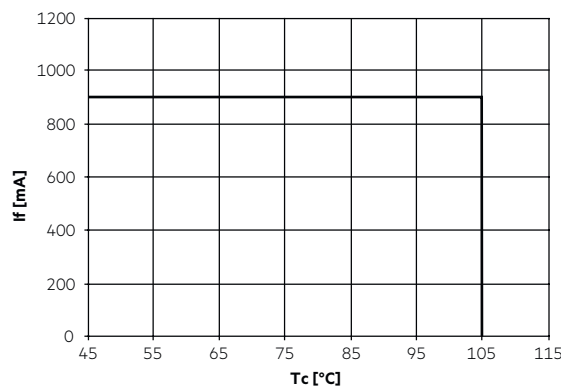

SLE G7 15mm 4000lm xx0 advanced

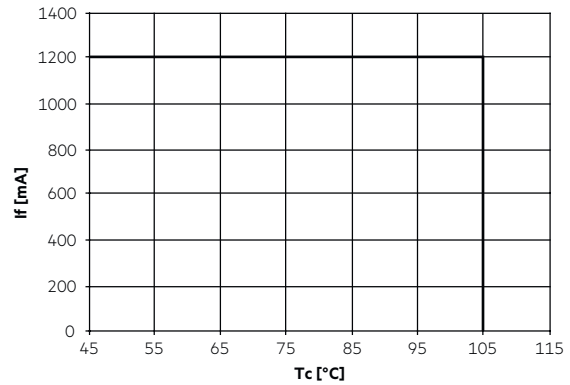

SLE G7 17mm 5000lm xx0 advanced

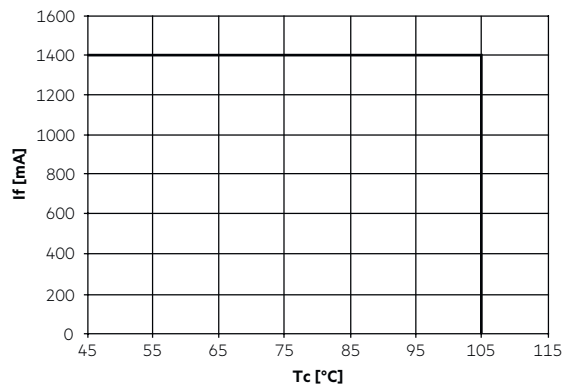

SLE G7 21mm 6000lm xx0 advanced

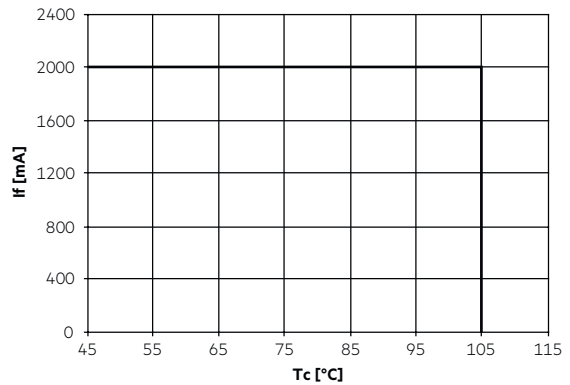

2.4 Thermal design and heat sink

The rated life of LED products depends to a large extent on the temperature. If the permissible temperature limits are exceeded, the life of the SLE G7 will be greatly reduced or the SLE G7 may be destroyed.

2.5 Heat sink values

SLE G7 09mm 1200lm xxx ADV

ta	tp	Operating current	R ^{th, hs-a}
25°C	65°C	250 mA	4.6 K/W
35°C	65°C	250 mA	3.4 K/W
45°C	65°C	250 mA	2.2 K/W
25°C	65°C	350 mA	3.1 K/W
35°C	65°C	350 mA	2.3 K/W
45°C	65°C	350 mA	1.5 K/W
25°C	65°C	500 mA	2.1 K/W
35°C	65°C	500 mA	1.6 K/W
45°C	65°C	500 mA	1.0 K/W

SLE G7 13mm 3000lm xxx ADV

ta	tp	Operating current	R ^{th, hs-a}
25°C	65°C	350 mA	3.4 K/W
35°C	65°C	350 mA	2.6 K/W
45°C	65°C	350 mA	1.7 K/W
25°C	65°C	500 mA	2.3 K/W
35°C	65°C	500 mA	1.7 K/W
45°C	65°C	500 mA	1.2 K/W
25°C	65°C	900 mA	1.2 K/W
35°C	65°C	900 mA	0.9 K/W
45°C	65°C	900 mA	0.6 K/W

SLE G7 15mm 4000lm xxx ADV

ta	tp	Operating current	R ^{th, hs-a}
25°C	65°C	500 mA	2.4 K/W
35°C	65°C	500 mA	1.8 K/W
45°C	65°C	500 mA	1.2 K/W
25°C	65°C	900 mA	1.3 K/W
35°C	65°C	900 mA	1.0 K/W
45°C	65°C	900 mA	0.6 K/W
25°C	65°C	1,200 mA	0.9 K/W
35°C	65°C	1,200 mA	0.7 K/W
45°C	65°C	1,200 mA	0.5 K/W

SLE G7 17mm 5000lm xxx ADV

ta	tp	Operating current	R ^{th, hs-a}
25°C	65°C	500 mA	2.3 K/W
35°C	65°C	500 mA	1.7 K/W
45°C	65°C	500 mA	1.1 K/W
25°C	65°C	1,050 mA	1.0 K/W
35°C	65°C	1,050 mA	0.7 K/W
45°C	65°C	1,050 mA	0.4 K/W
25°C	65°C	1,400 mA	0.7 K/W
35°C	65°C	1,400 mA	0.5 K/W
45°C	65°C	1,400 mA	0.3 K/W

SLE G7 21m 6000lm xxx ADV

ta	tp	Operating current	R ^{th, hs-a}
25°C	65°C	700 mA	1.6 K/W
35°C	65°C	700 mA	1.2 K/W
45°C	65°C	700 mA	0.8 K/W
25°C	65°C	1,400 mA	0.7 K/W
35°C	65°C	1,400 mA	0.5 K/W
45°C	65°C	1,400 mA	0.3 K/W
25°C	65°C	2,000 mA	0.5 K/W
35°C	65°C	2,000 mA	0.3 K/W
45°C	65°C	2,000 mA	0.2 K/W

Notes

The actual cooling can differ because of the material, the structural shape, outside influences and the installation situation. A thermal connection between SLE G7 and heat sink with heat-conducting paste or heat conducting adhesive film is absolutely necessary.

Additionally the SLE G7 has to be fixed on the heat sink with M3 screws to optimise the thermal connection.

Use of thermal interface material with thermal conductivity of $\lambda > 1$ W/mK and layer thickness of interface material with max. 50 μm or a similar interface material where the quotient of layer thickness and thermal conductivity $b < 50 \mu\text{mmK/W}$.

The SLE G7 H ADV T modules will be delivered with thermal interface foil of type GRAFTECH HT-1205A.

The bottom side of the thermal pad is glued to the module, the upper side is not adhesive. This makes it easier to position the module when it is connected to the heat sink.



The thermal pad is an integral part of the LED module and must not be confused with a protective foil. The thermal pad must not be pulled off!

For further information about the thermal interface foil please refer to the data sheet of the product GRAFTECH HT-1205A.

3. Installation / wiring

3.1 Electrical supply/choice of LED driver

SLE G7 from Tridonic are not protected against overvoltages, overcurrents, overloads or short-circuit currents. Safe and reliable operation can only be guaranteed in conjunction with a LED driver which complies with the relevant standards. The use of LED drivers from Tridonic in combination with SLE G7 guarantees the necessary protection for safe and reliable operation.

If a LED driver other than Tridonic is used, it must provide the following protection:

- Short-circuit protection
- Overload protection
- Overtemperature protection



SLE G7 must be supplied by a constant current LED driver. Operation with a constant voltage LED driver will lead to an irreversible damage of the module. Wrong polarity can damage the SLE G7.



SLE G7 must not be operated with nonSELV LED driver.



SLE G7 are basic insulated up to 60 V SELV against ground and can be mounted directly on earthed metal parts of the luminaire. If the max. output voltage of the LED driver (also against earth) is above 60 V SELV, an additional insulation between LED module and heat sink is required (for example by insulated thermal pads) or by a suitable luminaire construction.

At voltages > 60 V an additional protection against direct touch (test finger) to the light emitting side of the module has to be guaranteed. This is typically achieved by means of a non removable light distributor over the module.

3.2 Wiring

Wiring with housing (LES13 and LES15)

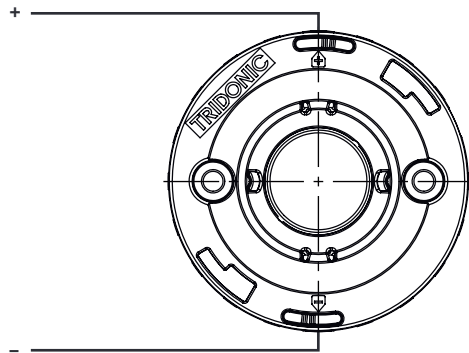

Wiring with housing (LES17 and LES21)

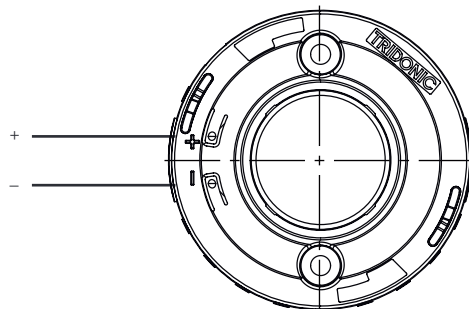

Wiring without housing

LES09

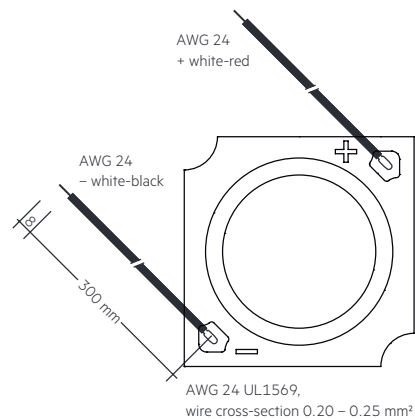

LES13

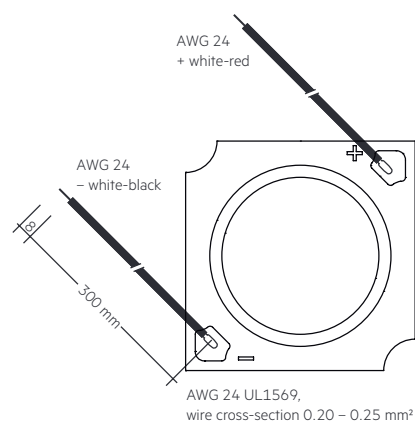

LES15

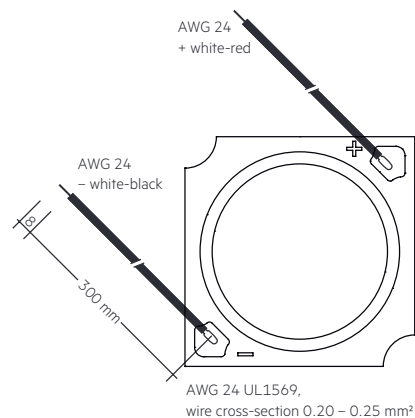

LES17 + LES21

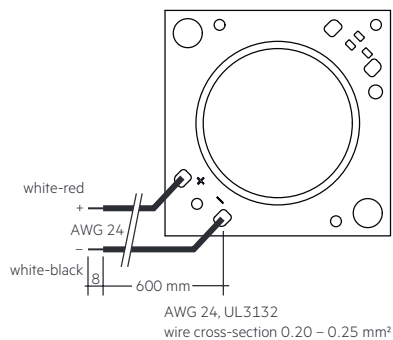
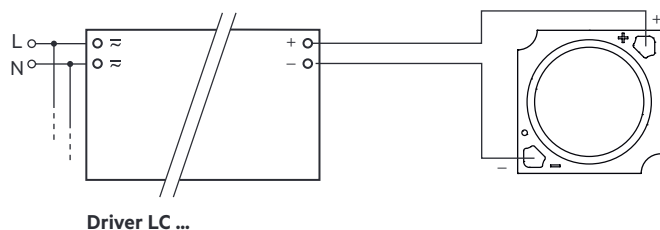
**Wiring example****3.3 Wiring type and cross section for housing variants**

For wiring use solid wire from 0.5 to 0.75 mm² or stranded wire with soldered ends of 0.5 mm².

For the push-wire connection you have to strip the insulation (6 – 7 mm).

Loosen wire through twisting and pulling.

wire preparation:

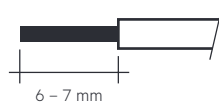
**3.4 Mounting instruction**

SLE G7 from Tridonic which have to be installed on a heat sink have to be connected with heat-conducting paste or heat conducting adhesive film and fixed with M3 screws.

The fixing/cooling surface must be cleaned by removing all dirt, dust and grease before installing the LED modules.

None of the components of the SLE G7 (substrate, LED, electronic components etc.) may be exposed to tensile or compressive stresses.



Max. torque for fixing: 0.3 Nm (LES9, LES13, LES15)
0.5 Nm (LES17, LES21)

The LED modules are mounted with 2 screws per module. In order not to damage the modules only rounded head screws and an additional plastic flat washer (notice working temperature) or rounded head screw with collar (ISO 7380-2) with head diameter ≤ 6.9 mm must be used for LED modules without housing (for LES13, LES15).

Chemical substance may harm the LED module. Chemical reactions could lead to colour shift, reduced luminous flux or a total failure of the module caused by corrosion of electrical connections.



Materials which are used in LED applications (e.g. sealings, adhesives) must not produce dissolver gas. They must not be condensation curing based, acetate curing based or contain sulfur, chlorine or phthalate.

Avoid corrosive atmosphere during usage and storage.

3.5 EOS/ESD safety guidelines

The device / module contains components that are sensitive to electrostatic discharge and may only be installed in the factory and on site if appropriate EOS/ESD protection measures have been taken. No special measures need be taken for devices/modules with enclosed casings (contact with the pc board not possible), just normal installation practice.

For further information for EOS/ESD safety guidelines and the ESD classification please refer to the brochure entitled <http://www.tridonic.com/esd-protection>.

4. Lifetime

4.1 Lifetime, lumen maintenance and failure rate

The light output of an LED module decreases over the lifetime, this is characterized with the L value. L70 means that the LED module will give 70 % of its initial luminous flux. This value is always related to the number of operation hours and therefore defines the lifetime of an LED module.

As the L value is a statistical value and the lumen maintenance may vary over the delivered LED modules. The B value defines the amount of modules which are below the specific L value, e.g. L70B10 means 10 % of the LED modules are below 70 % of the initial luminous flux, respectively 90 % will be above 70 % of the initial value.

In addition the percentage of failed modules (fatal failure) is characterized by the C value.

The F value is the combination of the B and C value. That means for F degradation and complete failures are considered, e.g. L70F10 means 10 % of the LED modules may fail or be below 70 % of the initial luminous flux.

4.2 Lumen maintenance

Lifetime declarations are informative and represent no warranty claim. Preliminary calculated lifetime data until LM80 test reports are available

SLE G7 09mm 1200lm ADV

Operating current	tp temperature	L90 / F10	L90 / F50	L80 / F10	L80 / F50	L70 / F10	L70 / F50
250 mA	65 °C	50,000 h	>55,000 h	>55,000 h	>55,000 h	>55,000 h	>55,000 h
	85 °C	50,000 h	>55,000 h	>55,000 h	>55,000 h	>55,000 h	>55,000 h
	105 °C	26,000 h	37,000 h	>55,000 h	>55,000 h	>55,000 h	>55,000 h
350 mA	65 °C	>55,000 h	>55,000 h	>55,000 h	>55,000 h	>55,000 h	>55,000 h
	85 °C	>55,000 h	>55,000 h	>55,000 h	>55,000 h	>55,000 h	>55,000 h
	105 °C	13,000 h	20,000 h	31,000 h	49,000 h	51,000 h	>55,000 h
500 mA	65 °C	>55,000 h	>55,000 h	>55,000 h	>55,000 h	>55,000 h	>55,000 h
	85 °C	>55,000 h	>55,000 h	>55,000 h	>55,000 h	>55,000 h	>55,000 h
	105 °C	13,000 h	20,000 h	31,000 h	49,000 h	51,000 h	>55,000 h

SLE G7 13mm 3000lm ADV

Operating current	tp temperature	L90 / F10	L90 / F50	L80 / F10	L80 / F50	L70 / F10	L70 / F50
350 mA	65 °C	50,000 h	>55,000 h	>55,000 h	>55,000 h	>55,000 h	>55,000 h
	85 °C	50,000 h	>55,000 h	>55,000 h	>55,000 h	>55,000 h	>55,000 h
	105 °C	26,000 h	37,000 h	>55,000 h	>55,000 h	>55,000 h	>55,000 h
500 mA	65 °C	50,000 h	>55,000 h	>55,000 h	>55,000 h	>55,000 h	>55,000 h
	85 °C	50,000 h	>55,000 h	>55,000 h	>55,000 h	>55,000 h	>55,000 h
	105 °C	26,000 h	37,000 h	>55,000 h	>55,000 h	>55,000 h	>55,000 h
900 mA	65 °C	37,000 h	51,000 h	>55,000 h	>55,000 h	>55,000 h	>55,000 h
	85 °C	37,000 h	51,000 h	>55,000 h	>55,000 h	>55,000 h	>55,000 h
	105 °C	13,000 h	20,000 h	31,000 h	49,000 h	50,000 h	>55,000 h

SLE G7 15mm 4000lm ADV

Operating current	tp temperature	L90 / F10	L90 / F50	L80 / F10	L80 / F50	L70 / F10	L70 / F50
500 mA	65 °C	50,000 h	>55,000 h	>55,000 h	>55,000 h	>55,000 h	>55,000 h
	85 °C	50,000 h	>55,000 h	>55,000 h	>55,000 h	>55,000 h	>55,000 h
	105 °C	26,000 h	37,000 h	>55,000 h	>55,000 h	>55,000 h	>55,000 h
900 mA	65 °C	50,000 h	>55,000 h	>55,000 h	>55,000 h	>55,000 h	>55,000 h
	85 °C	50,000 h	>55,000 h	>55,000 h	>55,000 h	>55,000 h	>55,000 h
	105 °C	26,000 h	37,000 h	>55,000 h	>55,000 h	>55,000 h	>55,000 h
1,200 mA	65 °C	>55,000 h	>55,000 h	>55,000 h	>55,000 h	>55,000 h	>55,000 h
	85 °C	>55,000 h	>55,000 h	>55,000 h	>55,000 h	>55,000 h	>55,000 h
	105 °C	13,000 h	20,000 h	31,000 h	49,000 h	51,000 h	>55,000 h

SLE G7 17mm 5000lm ADV

Operating current	tp temperature	L90 / F10	L90 / F50	L80 / F10	L80 / F50	L70 / F10	L70 / F50
500 mA	65 °C	50,000 h	>55,000 h	>55,000 h	>55,000 h	>55,000 h	>55,000 h
	85 °C	50,000 h	>55,000 h	>55,000 h	>55,000 h	>55,000 h	>55,000 h
	105 °C	26,000 h	37,000 h	>55,000 h	>55,000 h	>55,000 h	>55,000 h
1,050 mA	65 °C	50,000 h	>55,000 h	>55,000 h	>55,000 h	>55,000 h	>55,000 h
	85 °C	50,000 h	>55,000 h	>55,000 h	>55,000 h	>55,000 h	>55,000 h
	105 °C	26,000 h	37,000 h	>55,000 h	>55,000 h	>55,000 h	>55,000 h
1,400 mA	65 °C	>55,000 h	>55,000 h	>55,000 h	>55,000 h	>55,000 h	>55,000 h
	85 °C	>55,000 h	>55,000 h	>55,000 h	>55,000 h	>55,000 h	>55,000 h
	105 °C	13,000 h	20,000 h	31,000 h	50,000 h	51,000 h	>55,000 h

SLE G7 21mm 6000lm ADV

Operating current	tp temperature	L90 / F10	L90 / F50	L80 / F10	L80 / F50	L70 / F10	L70 / F50
700 mA	65 °C	50,000 h	>55,000 h	>55,000 h	>55,000 h	>55,000 h	>55,000 h
	85 °C	50,000 h	>55,000 h	>55,000 h	>55,000 h	>55,000 h	>55,000 h
	105 °C	26,000 h	37,000 h	>55,000 h	>55,000 h	>55,000 h	>55,000 h
1,400 mA	65 °C	50,000 h	>55,000 h	>55,000 h	>55,000 h	>55,000 h	>55,000 h
	85 °C	50,000 h	>55,000 h	>55,000 h	>55,000 h	>55,000 h	>55,000 h
	105 °C	26,000 h	37,000 h	>55,000 h	>55,000 h	>55,000 h	>55,000 h
2,000 mA	65 °C	>55,000 h	>55,000 h	>55,000 h	>55,000 h	>55,000 h	>55,000 h
	85 °C	>55,000 h	>55,000 h	>55,000 h	>55,000 h	>55,000 h	>55,000 h
	105 °C	13,000 h	20,000 h	31,000 h	50,000 h	51,000 h	>55,000 h

5. Electrical values

5.1 Declaration of electrical parameters

I_{rated} ... Nominal operating current the module is designed for.

I_{max} ... Max. permissible continuous operating current incl. The tolerances of the LED driver.

Max. permissible LF current ripple ... Max. output current of the LED driver incl. Tolerances and LF current ripple must not exceed this value.

Max. permissible peak current ... The max. output peak current of the LED driver must not exceed this value.

5.2 Typ. forward voltage vs. forward current

SLE G7 09mm 1200lm xxx ADV

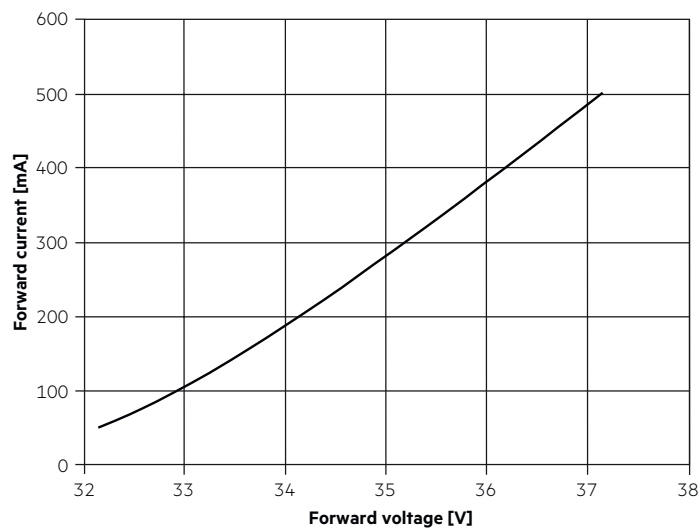

SLE G7 15mm 4000lm xxx ADV

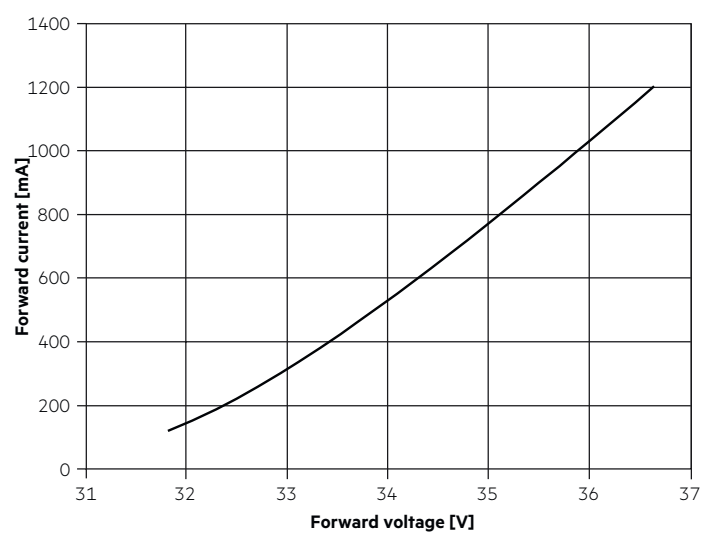

SLE G7 13mm 3000lm xxx ADV

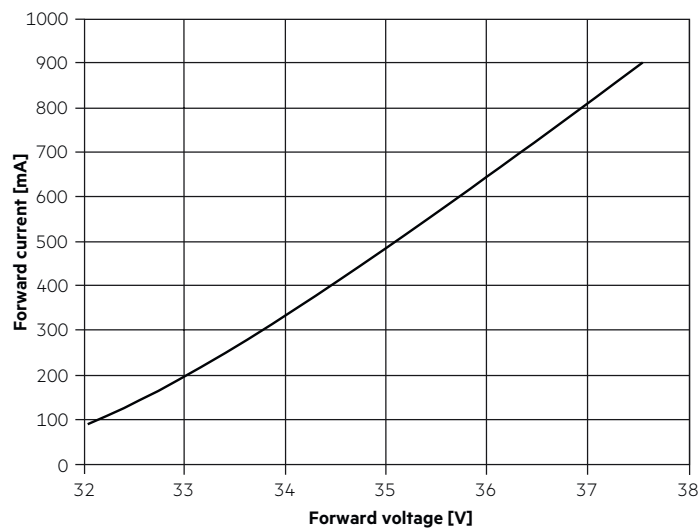

SLE G7 17mm 5000lm xxx ADV

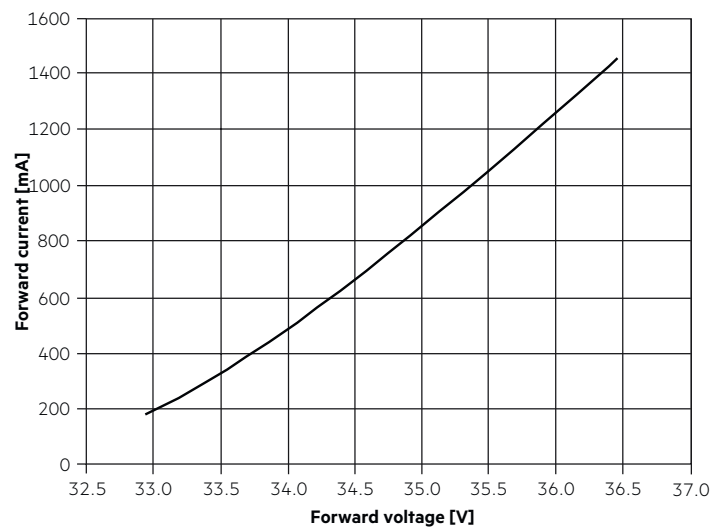

SLE G7 21mm 6000lm xxx ADV

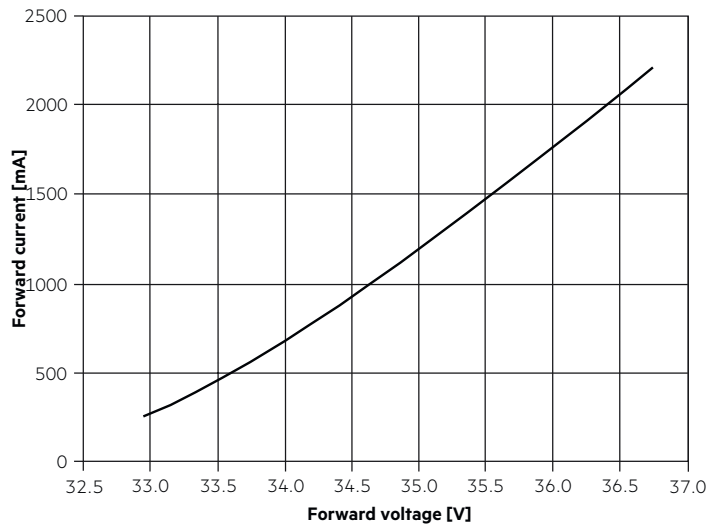

5.3 Forward voltage vs. tp temperature

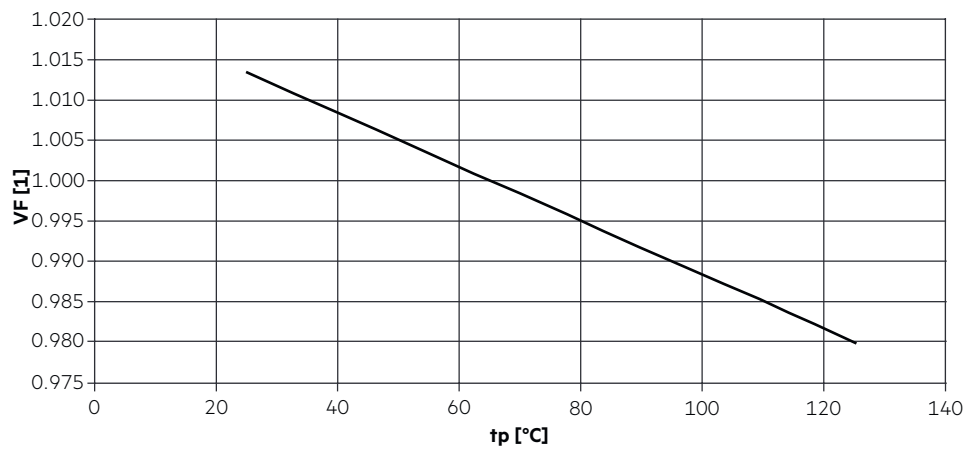

The diagrams based on statistic values.
The real values can be different.

6. Photometric characteristics

6.1 Coordinates and tolerances according to CIE 1931 and colour rendering

The specified colour coordinates are measured integral after a settling time of 100 ms. The current impuls depends on the module type. The ambient temperature of the measurement is $t_a = 25^\circ\text{C}$. The measurement tolerance of the colour coordinates are ± 0.01 .

Module type	Current impulse
SLE G7 09mm 1200lm xxx ADV	350 mA
SLE G7 13mm 3000lm xxx ADV	500 mA
SLE G7 15mm 4000lm xxx ADV	900 mA
SLE G7 17mm 5000lm xxx ADV	1,050 mA
SLE G7 21mm 6000lm xxx ADV	1,400 mA

2,700 K – CRI80

	x0	y0
Centre	0.4599	0.4106

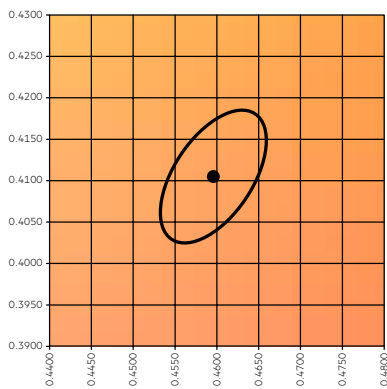

MacAdam ellipse: 3SDCM

TM30		CRI	
Rf	Rg	Ra	R9
82	92	81	12

Colour vector graphic

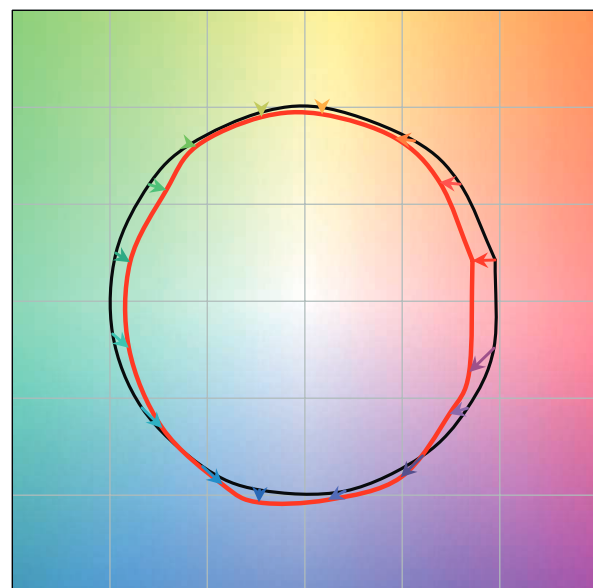

— Reference source
— Test source

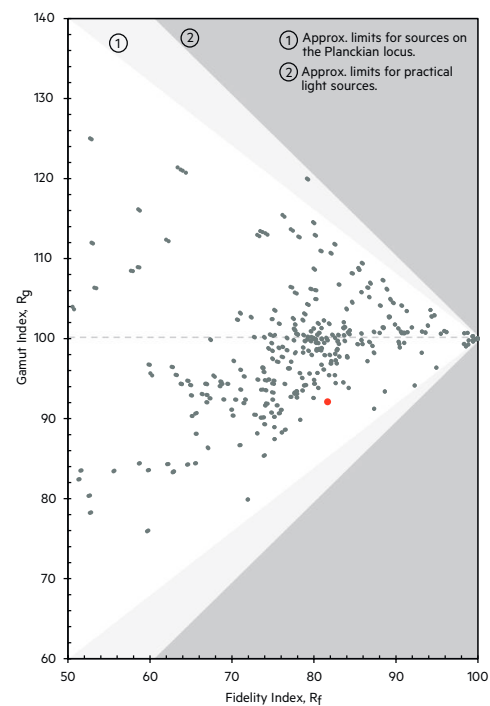
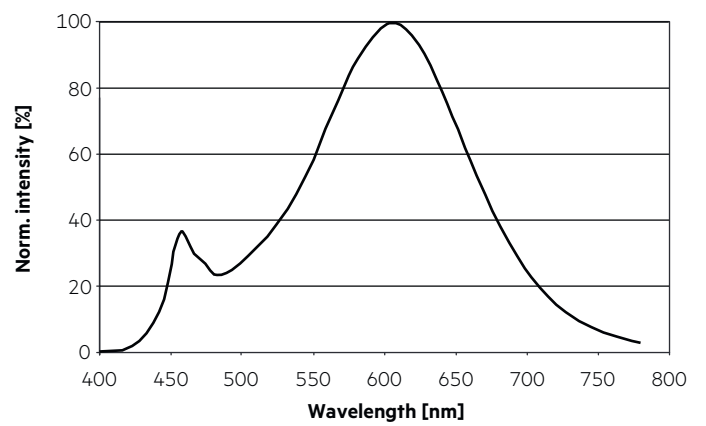

2,700 K – CRI90

	x0	y0
Centre	0.4599	0.4106

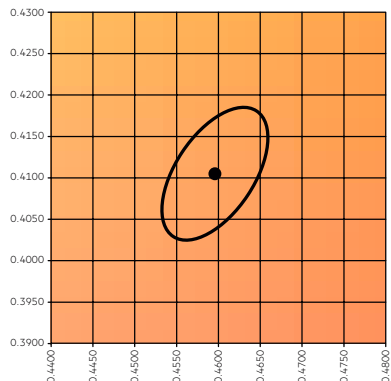

MacAdam ellipse: 3SDCM

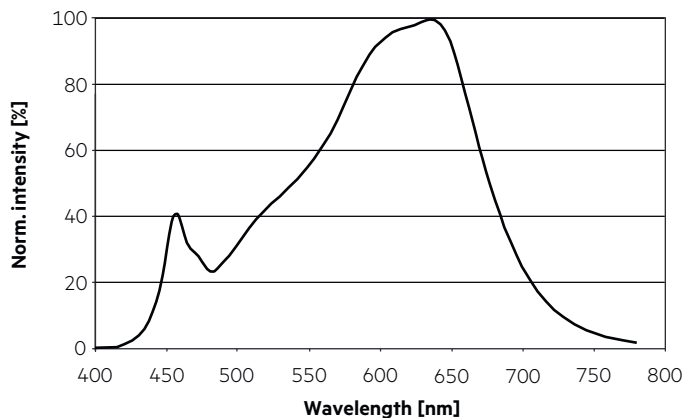

TM30		CRI	
Rf	Rg	Ra	R9
89	97	91	56

Colour vector graphic

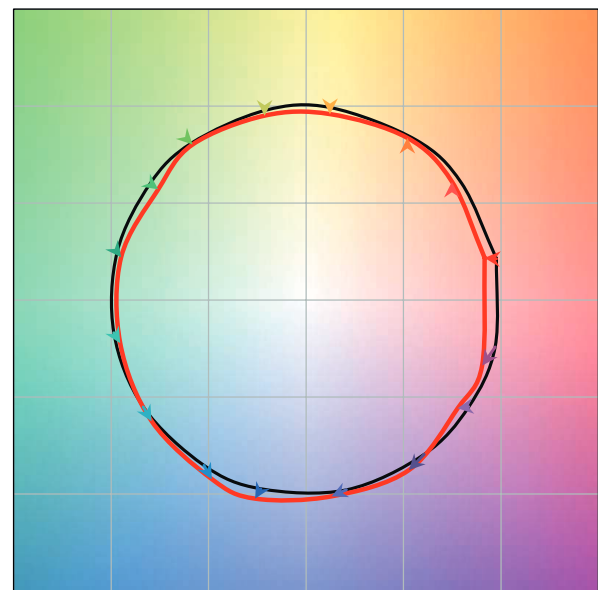

— Reference source
 — Test source

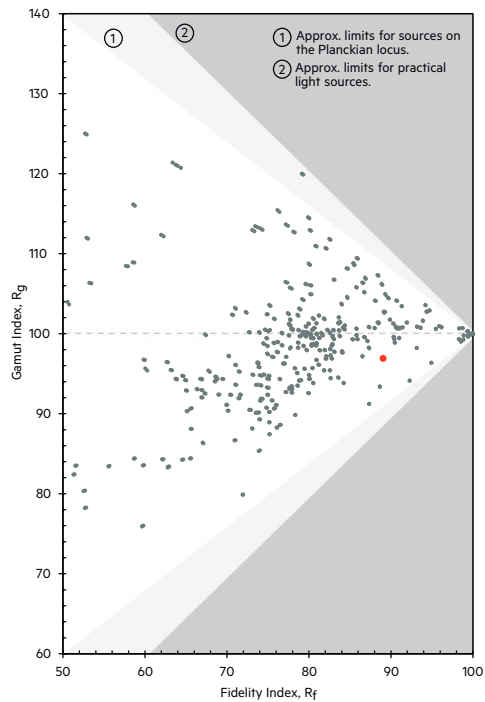

3,100 K - CRI80

	x0	y0
Centre	0.4300	0.4016

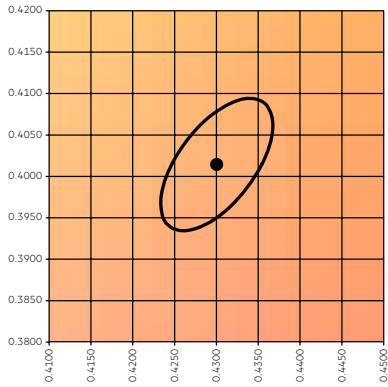

MacAdam ellipse: 3SDCM

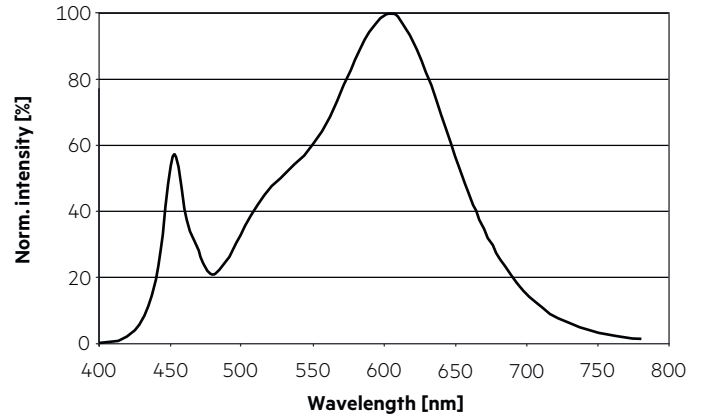

TM30		CRI	
Rf	Rg	Ra	R9
84	96	83	8

Colour vector graphic

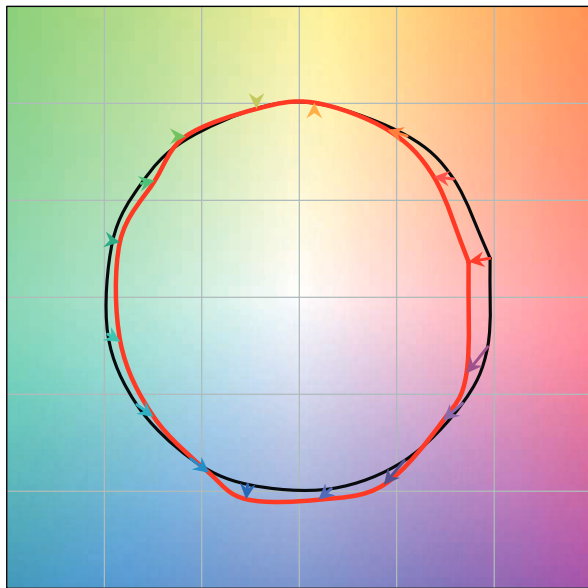

— Reference source
 — Test source

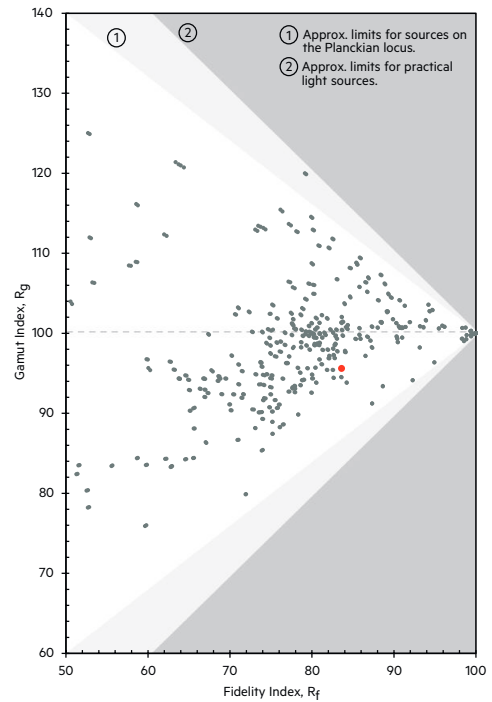

3,100 K - CRI90

	x0	y0
Centre	0.4300	0.4016

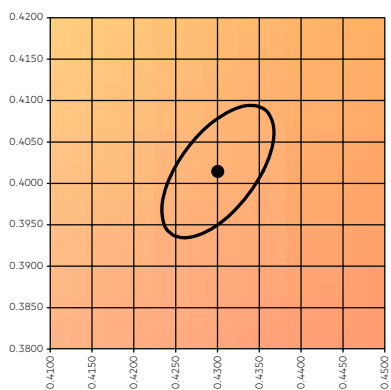

MacAdam ellipse: 3SDCM

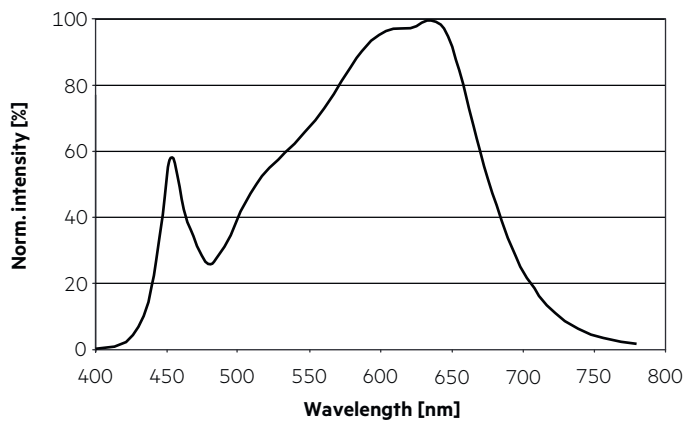

TM30		CRI	
Rf	Rg	Ra	R9
90	98	92	59

Colour vector graphic

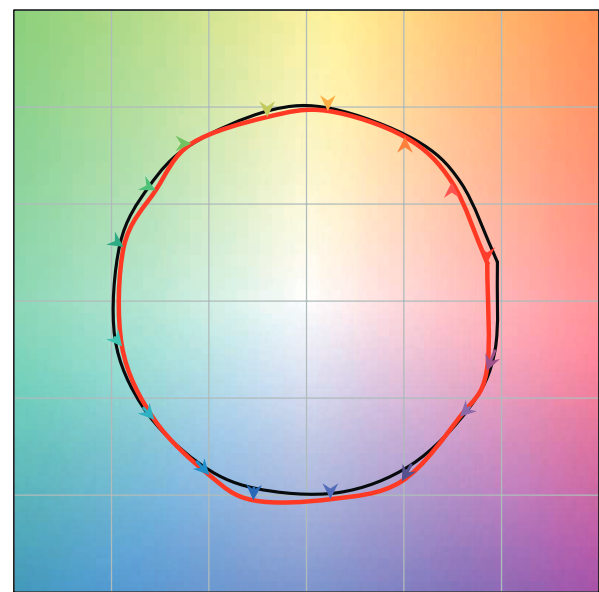

— Reference source
— Test source

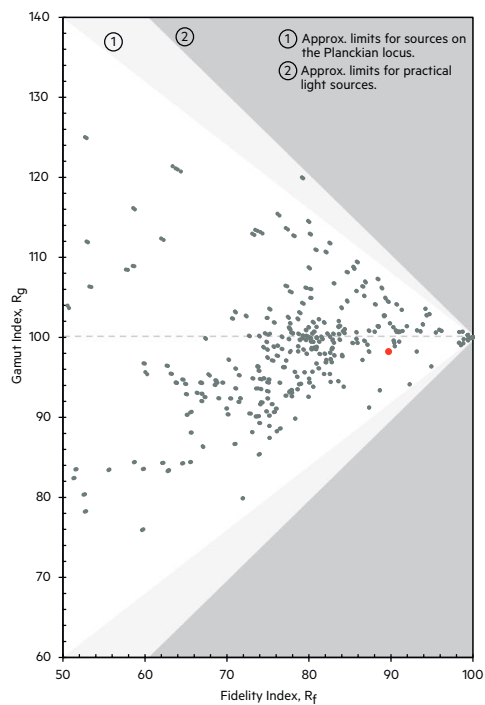

3,500 K - CRI80

	x0	y0
Centre	0.4053	0.3907

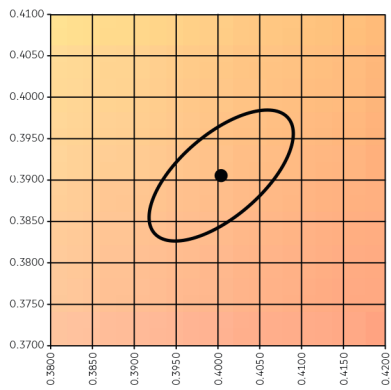

MacAdam ellipse: 3SDCM

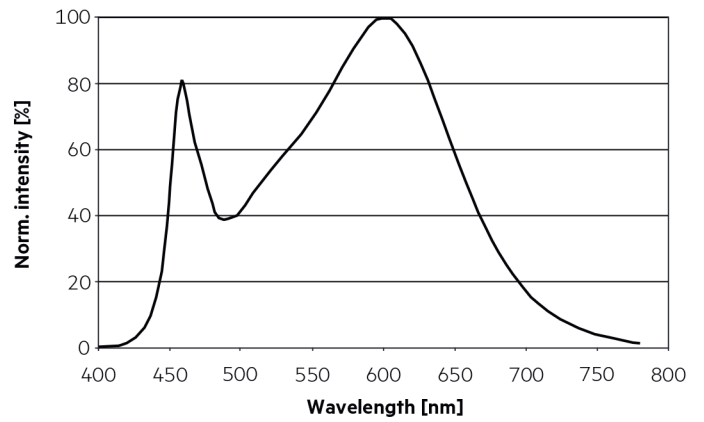

TM30		CRI	
Rf	Rg	Ra	R9
82	91	85	22

Colour vector graphic

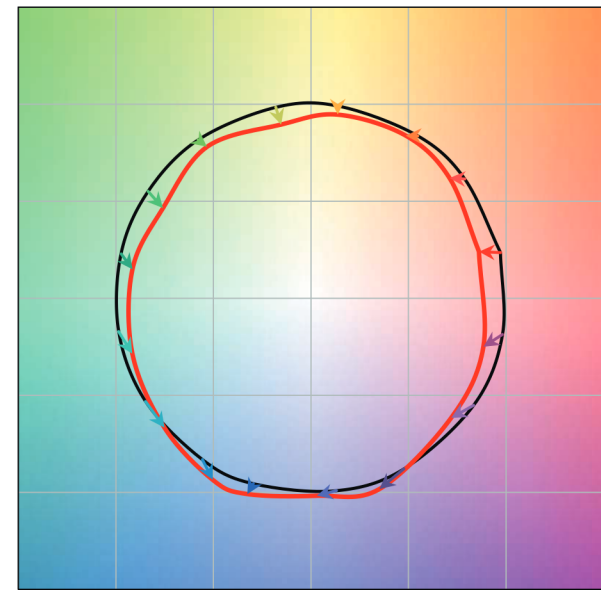

— Reference source
 — Test source

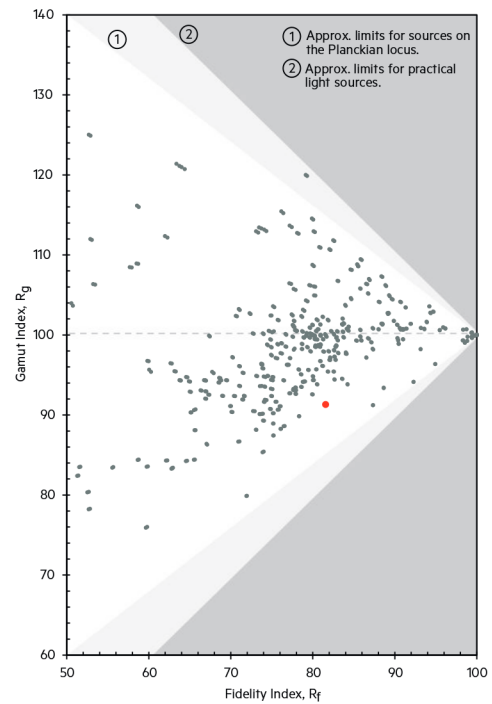

3,500 K - CRI90

	x0	y0
Centre	0.4053	0.3907

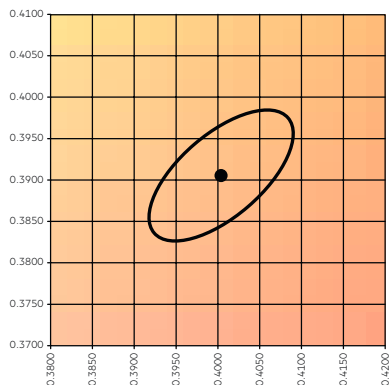

MacAdam ellipse: 3SDCM

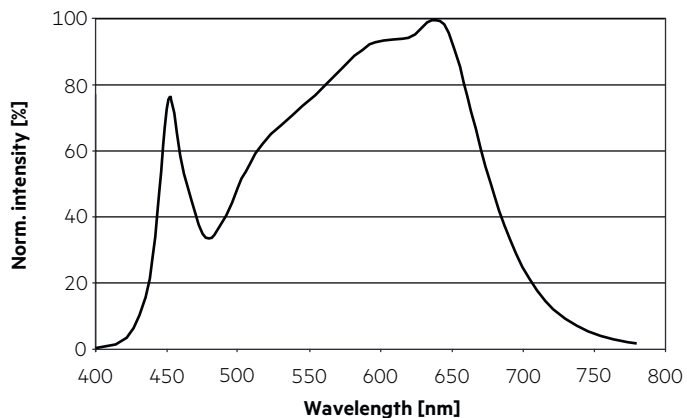

TM30		CRI	
Rf	Rg	Ra	R9
90	98	94	70

Colour vector graphic

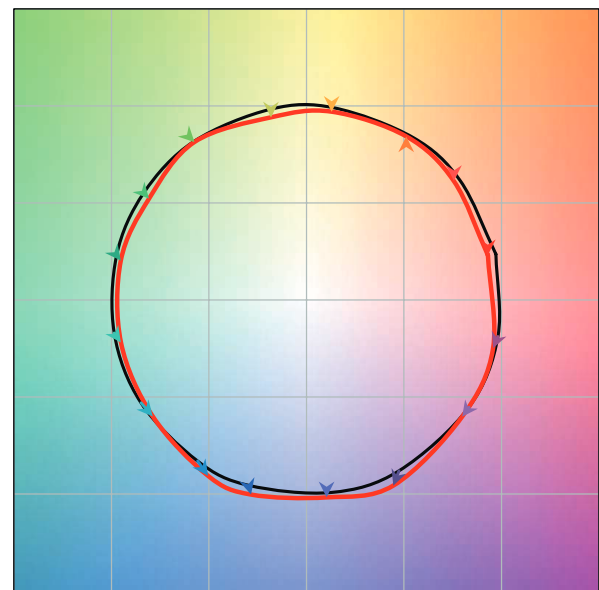

— Reference source
 — Test source

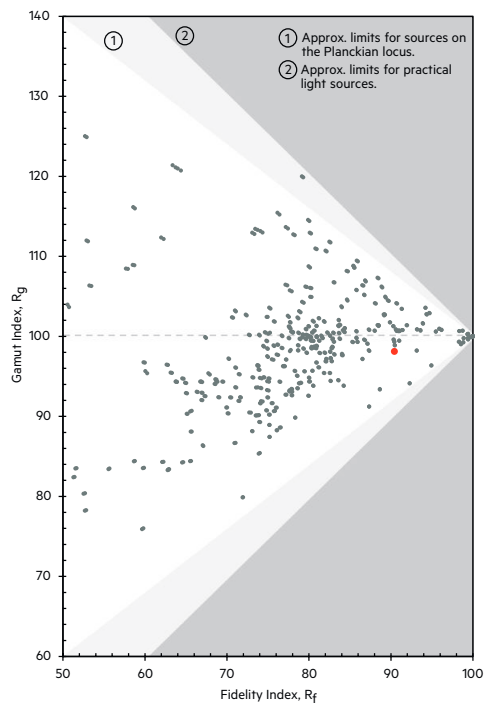

4,100 K - CRI80

	x0	y0
Centre	0.3761	0.3740

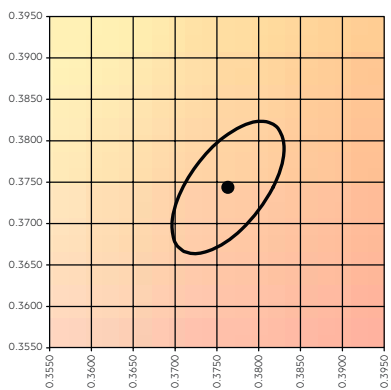

MacAdam ellipse: 3SDCM

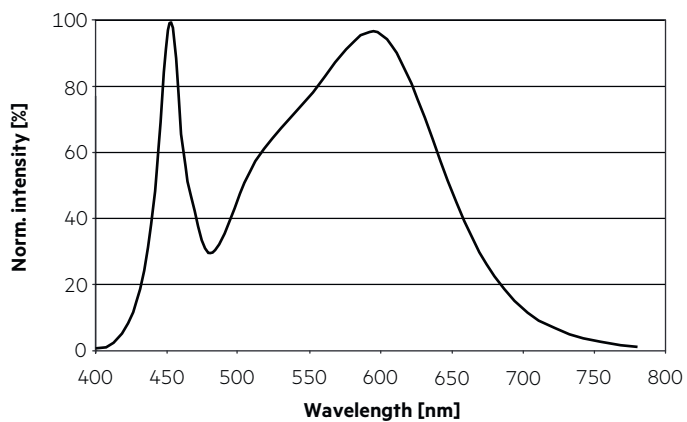

TM30		CRI	
Rf	Rg	Ra	R9
82	95	83	5

Colour vector graphic

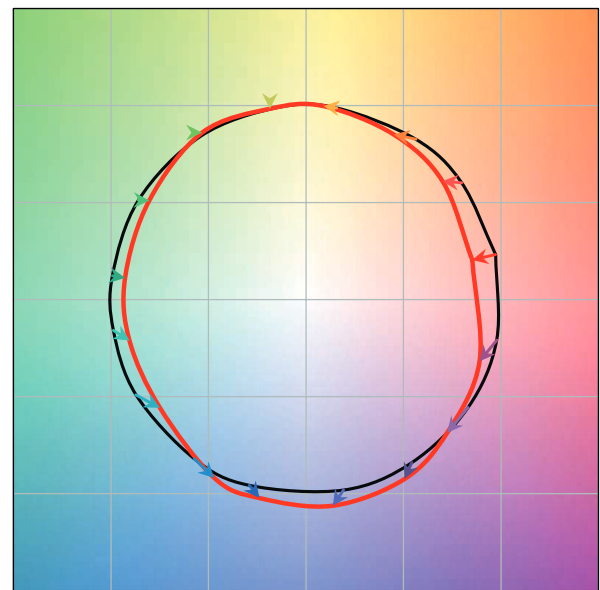

— Reference source
 — Test source

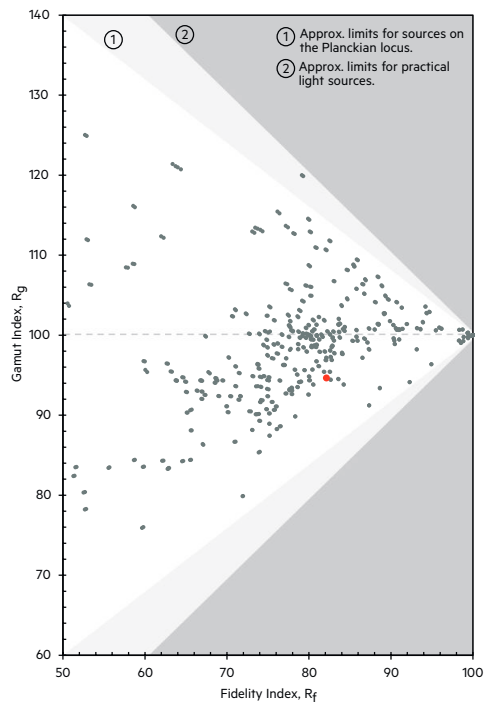

4,100 K – CRI90

	x0	y0
Centre	0.3761	0.3740

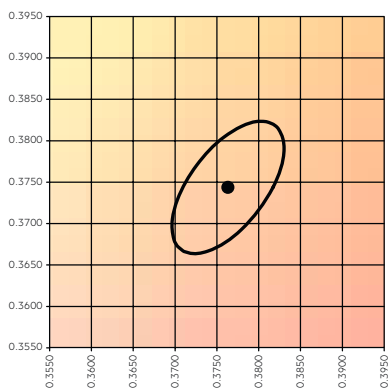

MacAdam ellipse: 3SDCM

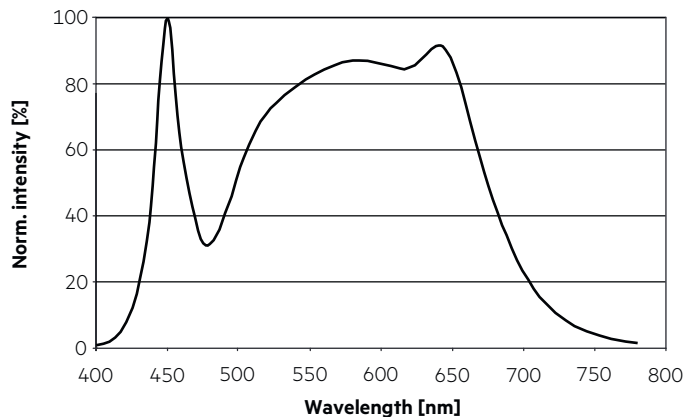

TM30		CRI	
Rf	Rg	Ra	R9
90	100	91	70

Colour vector graphic

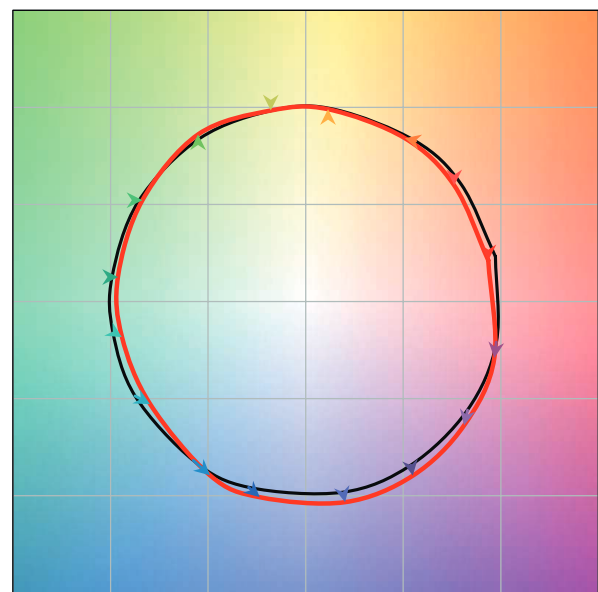

— Reference source
 — Test source

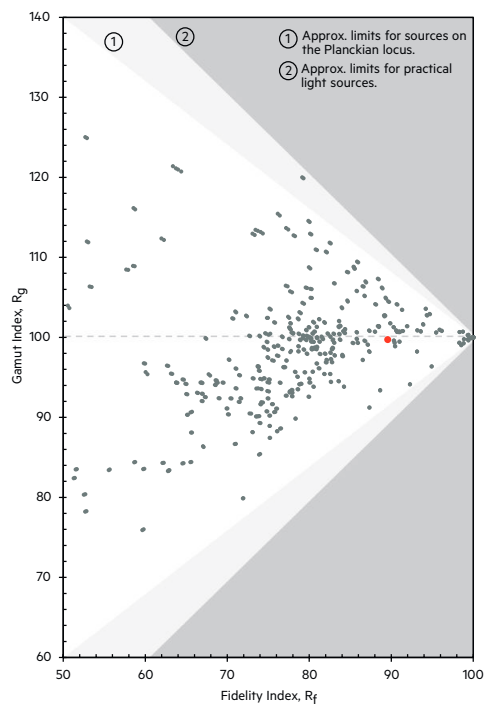

6.2 Light distribution

The optical design of the SLE product line ensures optimum homogeneity for the light distribution.

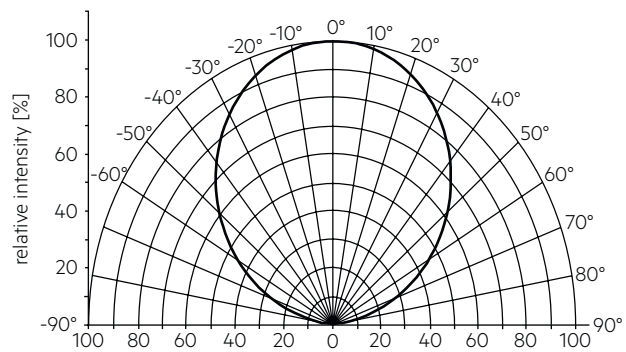

6.3 Relative luminous flux vs. tp temperature

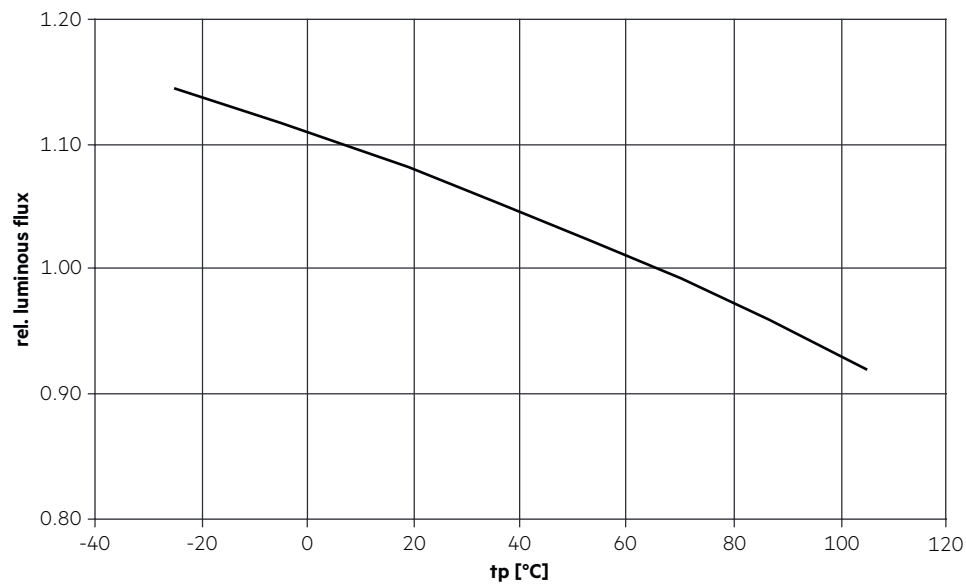

6.4 Relative luminous flux vs. operating current

SLE G7 09mm 1200lm xxx ADV

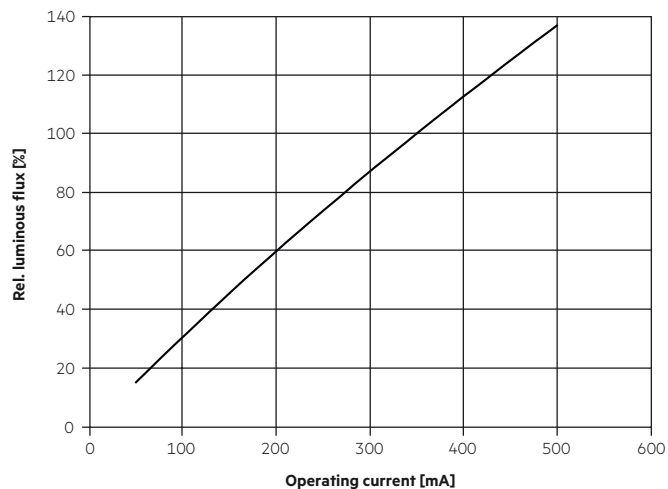

SLE G7 17mm 5000lm xxx ADV

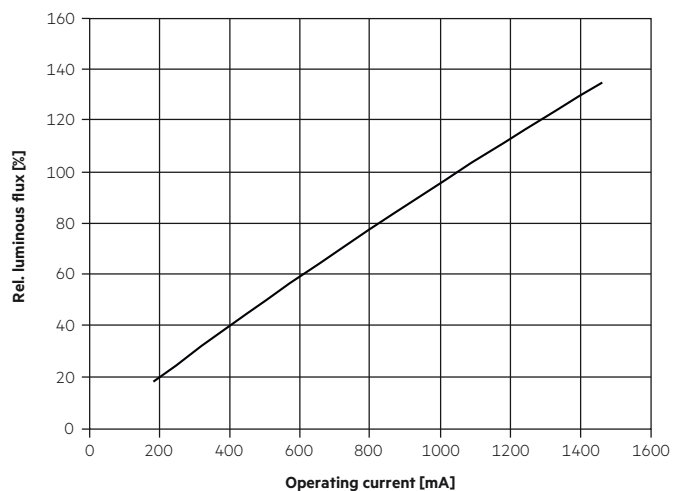

SLE G7 13mm 3000lm xxx ADV

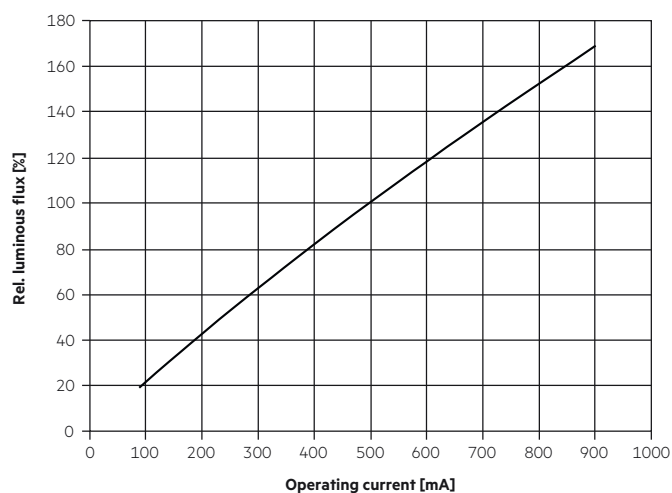

SLE G7 21mm 6000lm xxx ADV

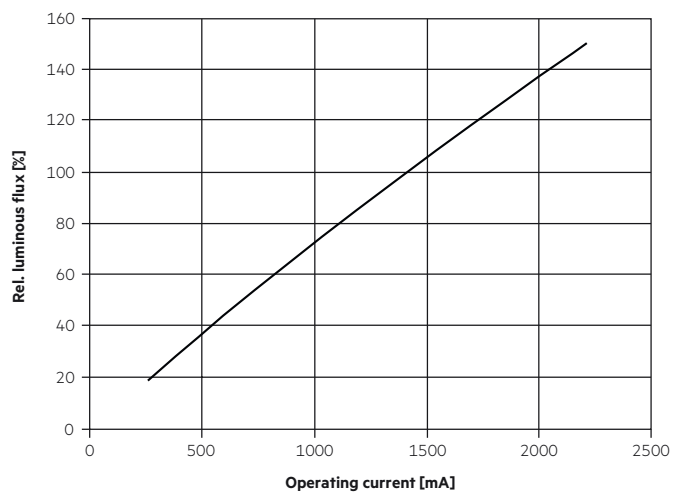

SLE G7 15mm 4000lm xxx ADV

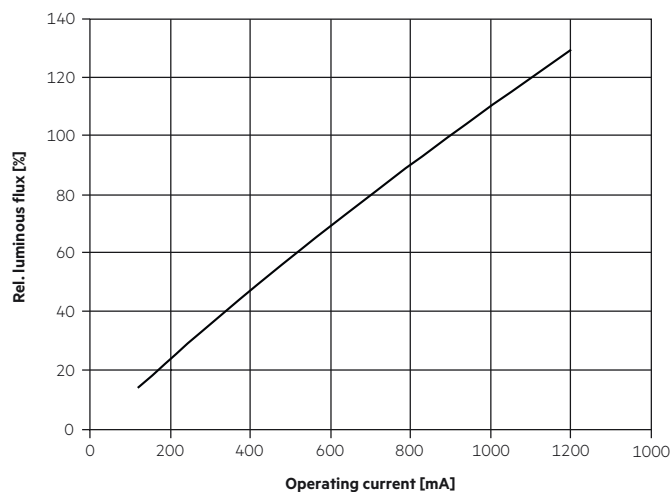

7. Miscellaneous

7.1 Additional information

Additional technical information at www.tridonic.com → Technical Data

Guarantee conditions at www.tridonic.com → Services

Lifetime declarations are informative and represent no warranty claim.

Colour rendering information are typical values and represent no warranty claim.