

Module LLE 24mm 2000lm CRI90 HV ADV5

Modules LLE advanced



LLE 24x280mm 2000lm HV ADV5



LLE 24x560mm 4000lm HV ADV5



For articles manufactured at Tridonic SRB d.o.o.

Product description

- _ Ideal for linear and panel lights
- _ 2 terminals for serial wiring
- _ Perfectly uniform light, even if several LED modules are used together in a line
- _ Push terminals for quick and simple wiring of LED module to LED module
- _ Broad portfolio from extruded lenses and covers available
- _ HE ... High Efficiency, NM ... Nominal Mode, HO ... High Output
- _ Long lifetime up to 72,000 hours
- _ 5 years guarantee (Conditions at <https://www.tridonic.com/manufacturer-guarantee-conditions>)

Optical properties

- _ Colour temperatures 3,000 and 4,000 K
- _ Useful luminous flux 3,510 lm at Irated and tp = 25 °C
- _ Efficacy of the LED module 162 lm/W at Irated and tp = 25 °C
- _ High colour rendering index CRI > 90
- _ High colour consistency (MacAdam 3) ①
- _ Small luminous flux tolerances

Mechanical properties

- _ Module dimension 24 x 280 mm and 24 x 560 mm (ZHAGA compliant)
- _ Simple installation via clips or screws

System solution

- _ Combine Tridonic's LED modules and dimmable drivers to achieve an outstanding system efficacy (configuration possible via <https://setbuilder.tridonic.com/>)

① Integral measurement over the complete module.

Website

<http://www.tridonic.com/28003979>

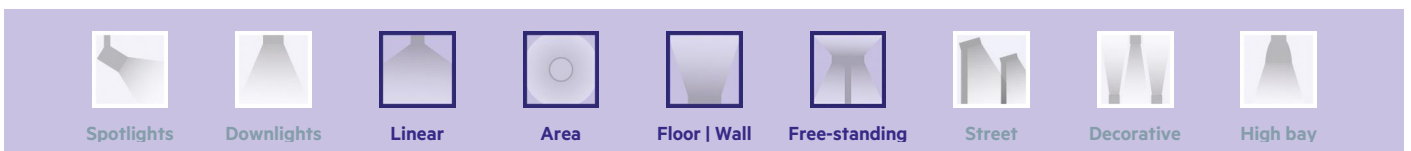
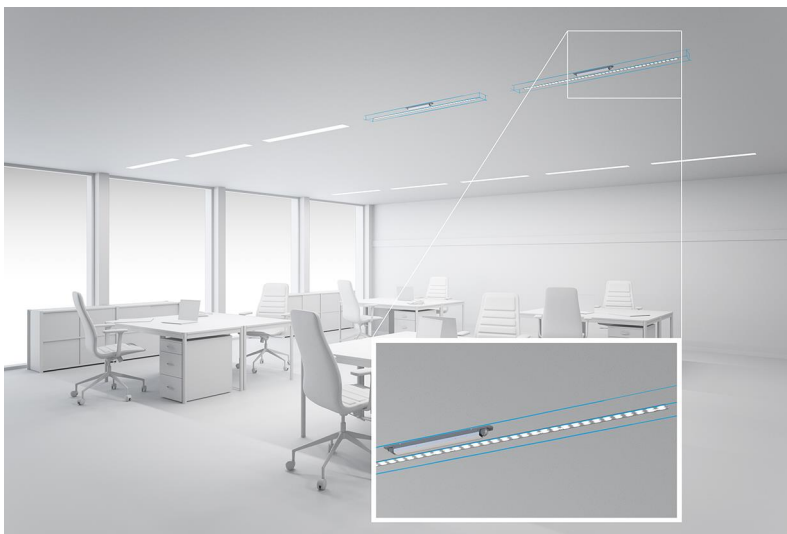

Module LLE 24mm 2000lm CRI90 HV ADV5

Modules LLE advanced

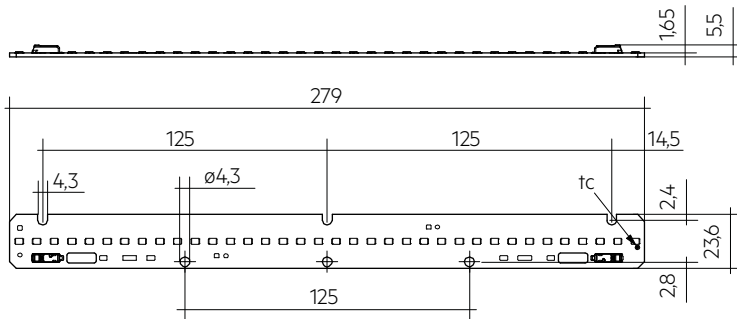

LLE 24x280mm 2000lm HV ADV5

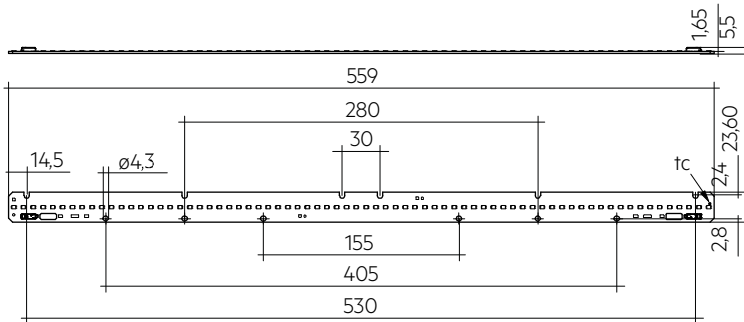

LLE 24x560mm 4000lm HV ADV5

Ordering data

Type	Article number	Colour temperature	Packaging, carton	Weight per pc.
LLE 24x280mm 2000lm 930 HV ADV5	28003979	3,000 K	108 pc(s).	0.023 kg
LLE 24x280mm 2000lm 940 HV ADV5	28003980	4,000 K	108 pc(s).	0.023 kg
LLE 24x560mm 4000lm 930 HV ADV5	28003981	3,000 K	108 pc(s).	0.046 kg
LLE 24x560mm 4000lm 940 HV ADV5	28003982	4,000 K	108 pc(s).	0.046 kg

Technical data

Beam characteristic	120°
Ambient temperature t_a	-40 ... +65 °C
t_p rated	65 °C
t_c	95 °C
I_{rated}	325 mA
I_{max}	540 mA
Max. permissible LF current ripple	595 mA
Max. permissible peak current	900 mA / max. 10 ms
Max. working voltage for insulation [®]	320 V
Insulation test voltage	1.64 kV
CTI of the printed circuit board	≥ 600
ESD classification	Severity level 4
Risk group (IEC 62471) at ≤ 310 mA	RG0
Risk group (IEC 62471) at I_{max}	RG1
Classification acc. to IEC 62031	Built-in
Type of protection	IPO0
Lumen maintenance L70B50	72,000 h
Guarantee (conditions at www.tridonic.com)	5 Year(s)

Approval marks**Standards**

IEC 62031, IEC 62471, IEC 61000-4-2, IEC 62778, IEC 61547, UL 8750

Specific technical data

Type	Article number	Photometric code	Useful luminous flux at $t_p = 25\text{ °C}$ ^③	Expected luminous flux at t_p rated ^④	Typ. forward current	Min. forward voltage at t_p rated ^⑤	Max. forward voltage at $t_p = 25\text{ °C}$ ^⑥	Power consumption P_{on} at $t_p = 25\text{ °C}$ ^⑥	Efficacy of the module at $t_p = 25\text{ °C}$	Expected efficacy of the module at t_p rated	Colour rendering index CRI
Operating mode HE at 200 mA											
LLE 24x280mm 2000lm 930 HV ADV5	28003979	930/359	-	1,041 lm	200 mA	30.9 V	33.6 V	-	-	161 lm/W	> >90
LLE 24x280mm 2000lm 940 HV ADV5	28003980	940/359	-	1,077 lm	200 mA	30.9 V	33.6 V	-	-	167 lm/W	> >90
LLE 24x560mm 4000lm 930 HV ADV5	28003981	930/359	-	2,053 lm	200 mA	61.8 V	67.3 V	-	-	159 lm/W	> >90
LLE 24x560mm 4000lm 940 HV ADV5	28003982	940/359	-	2,160 lm	200 mA	61.8 V	67.3 V	-	-	168 lm/W	> >90
Operating mode NM at 325 mA											
LLE 24x280mm 2000lm 930 HV ADV5	28003979	930/359	1,682 lm	1,612 lm	325 mA	31.6 V	34.4 V	10.9 W	155 lm/W	150 lm/W	> >90
LLE 24x280mm 2000lm 940 HV ADV5	28003980	940/359	1,755 lm	1,675 lm	325 mA	31.6 V	34.4 V	10.9 W	161 lm/W	155 lm/W	> >90
LLE 24x560mm 4000lm 930 HV ADV5	28003981	930/359	3,332 lm	3,193 lm	325 mA	63.3 V	68.8 V	21.7 W	153 lm/W	148 lm/W	> >90
LLE 24x560mm 4000lm 940 HV ADV5	28003982	940/359	3,510 lm	3,360 lm	325 mA	63.3 V	68.8 V	21.7 W	162 lm/W	156 lm/W	> >90
Operating mode HO at 500 mA											
LLE 24x280mm 2000lm 930 HV ADV5	28003979	930/359	-	2,413 lm	500 mA	32.5 V	35.3 V	-	-	142 lm/W	> >90
LLE 24x280mm 2000lm 940 HV ADV5	28003980	940/359	-	2,503 lm	500 mA	32.5 V	35.3 V	-	-	148 lm/W	> >90
LLE 24x560mm 4000lm 930 HV ADV5	28003981	930/359	-	4,770 lm	500 mA	65.1 V	70.6 V	-	-	140 lm/W	> >90
LLE 24x560mm 4000lm 940 HV ADV5	28003982	940/359	-	5,020 lm	500 mA	65.1 V	70.6 V	-	-	148 lm/W	> >90

② If mounted with M4 screws and plastic washers.

③ Tolerance of useful light flux - 0 % / + 15 %. Measurement uncertainty ± 10 %.

④ Tolerance of expected light flux - 0 % / + 15 %. Measurement uncertainty ± 10 %. Based on calculation.

⑤ Measurement tolerance forward voltage: ±0.1 V.

⑥ Tolerance of power consumption P_{on} ± 10 %. Measurement uncertainty ± 5 %.

LINEAR COVER LLE

Accessory

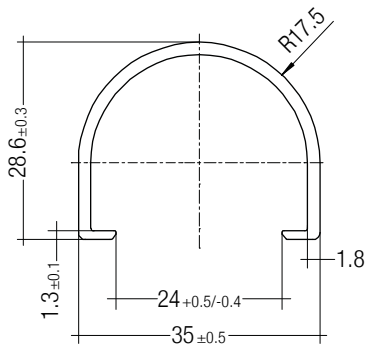

Product description

- _ LINEAR COVER for LLE
- _ Protection against direct touch for non-SELV applications (recommendation LLE 20: use all fixing points and screwed Endcap, recommendation LLE 24: use all fixing points)
- _ Fast snap on mounting on to LLE 20: with M4 screws and plastic washers, to LLE 24: with clips or plastic washers
- _ High transmission: transparent, semi-transparent and diffuse
- _ Material: PMMA
- _ Tolerances: ± 1 mm for 597 mm length (ends finished), + 10 mm from length 1,150 mm (ends raw)

Website

<http://www.tridonic.com/28000338>



Ordering data

Type	Article number	Colour	Length L	Efficiency	Packaging, carton	Weight per pc.
LINEAR COVER SY Transparent 1600mm	28000338	Transparent	1,600 mm	94 %	12 pc(s).	0.272 kg
LINEAR COVER SY Frosted 1800mm	28000437	Semi-transparent	1,800 mm	87 %	12 pc(s).	0.308 kg
LINEAR COVER SY Frosted 1600mm	28000339	Semi-transparent	1,600 mm	87 %	12 pc(s).	0.272 kg
LINEAR COVER SY Frosted 1500mm	28000435	Semi-transparent	1,500 mm	87 %	12 pc(s).	0.244 kg
LINEAR COVER SY Frosted 1200mm	28000422	Semi-transparent	1,200 mm	87 %	12 pc(s).	0.205 kg
LINEAR COVER SY Frosted 597mm	28000340	Semi-transparent	597 mm	87 %	12 pc(s).	0.102 kg
LINEAR COVER SY Diffuse 1800mm	28000438	Diffuse	1,800 mm	76 %	12 pc(s).	0.308 kg
LINEAR COVER SY Diffuse 1600mm	28000341	Diffuse	1,600 mm	76 %	12 pc(s).	0.272 kg
LINEAR COVER SY Diffuse 1500mm	28000436	Diffuse	1,500 mm	76 %	12 pc(s).	0.257 kg
LINEAR COVER SY Diffuse 1200mm	28000434	Diffuse	1,200 mm	76 %	12 pc(s).	0.205 kg
LINEAR COVER SY Diffuse 597mm	28000342	Diffuse	597 mm	76 %	12 pc(s).	0.102 kg

ACL ENDCAP LLE

Accessory

**Product description**

- _ ENDCAP for LLE
- _ PUSH-FIX: Fast snap on mounting (sheet thickness 0.5 – 1.0 mm), for drilling hole 4 mm
- _ SCREW-FIX: Screw mounting with EJOT Delta PT WN 5451 30x8 (not included), tightening torque 0.7 Nm
- _ Clip made of polycarbonate

Website

<http://www.tridonic.com/28001037>

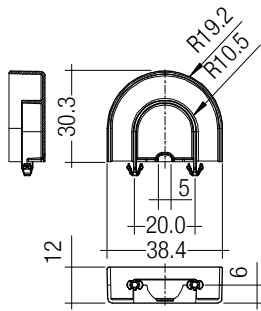
**Ordering data**

Type	Article number	Colour	Packaging, carton	Weight per pc.
ACL ENDCAP LLE24 PUSH-FIX	28001037	White	480 pc(s).	0.003 kg
ACL ENDCAP LLE24 SCREW-FIX	28002315	White	480 pc(s).	0.003 kg

ACL LINEAR LENS 24mm

Accessory

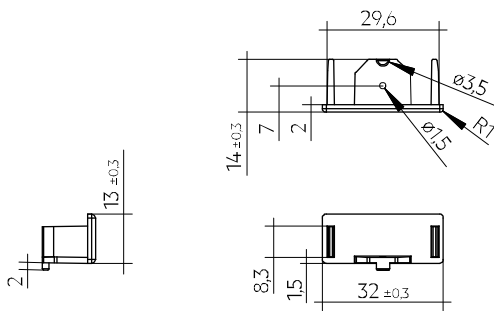
**Product description LINEAR LENS**

- _ Linear lens for LLE 20 / 24
- _ Available with different beam characteristics
- _ Protection against direct touch for non-SELV applications (recommendation: use all fixing points)
- _ Fast snap on mounting on to LLE 20: with M4 screws and plastic washers, to LLE 24: with clips or plastic washers
- _ Recommendation: Fastening with screws and plastic washers, see 2.3 Heat sink specifications in data sheet
- _ Material: PMMA
- _ Available lengths: 1,200, 1,500 and 1,800 mm, Tolerance: + 10 mm (ends raw)
- _ Max. permissible temperature 80 °C
- _ Photometric data available on website

Product description Endcap

- _ ENDCAP for LINEAR LENS 24mm INTENSE, ASY and DASY
- _ Mounting by clipping in and screwing from below using screw EJOT Delta PT WN 5451 20x4, tightening torque 0.7 Nm
- _ Made of Polyamide UL94 V0

Website

<http://www.tridonic.com/28001428>

**Ordering data**

Type	Article number	Length L	Beam characteristic	Efficiency	Packaging, carton	Weight per pc.
ACL LINEAR LENS 24x1200mm 60°	28001428	1,200 mm	60°	97 %	21 pc(s).	0.196 kg
ACL LINEAR LENS 24x1200mm 90°	28001429	1,200 mm	90°	97 %	21 pc(s).	0.165 kg
ACL LINEAR LENS 24x1500mm 60°	28000953	1,500 mm	60°	97 %	21 pc(s).	0.261 kg
ACL LINEAR LENS 24x1500mm 90°	28000955	1,500 mm	90°	97 %	21 pc(s).	0.221 kg
ACL LINEAR LENS 24x1200mm INTENSE	28002024	1,200 mm	40°	95 %	18 pc(s).	0.261 kg
ACL LINEAR LENS 24x1500mm INTENSE	28002025	1,500 mm	40°	95 %	18 pc(s).	0.326 kg
ACL LINEAR LENS 24x1800mm INTENSE	28002026	1,800 mm	40°	95 %	18 pc(s).	0.392 kg
ACL LINEAR LENS 24x1200mm BATWING	28002027	1,200 mm	batwing	95 %	18 pc(s).	0.275 kg
ACL LINEAR LENS 24x1500mm BATWING	28002028	1,500 mm	batwing	95 %	18 pc(s).	0.344 kg
ACL LINEAR LENS 24x1800mm BATWING	28002029	1,800 mm	batwing	95 %	18 pc(s).	0.412 kg
ACL LINEAR LENS 24x1200mm ASY	28002030	1,200 mm	asymmetric	95 %	18 pc(s).	0.250 kg
ACL LINEAR LENS 24x1500mm ASY	28002031	1,500 mm	asymmetric	95 %	18 pc(s).	0.312 kg
ACL LINEAR LENS 24x1800mm ASY	28002032	1,800 mm	asymmetric	95 %	18 pc(s).	0.375 kg
ACL LINEAR LENS 24x1200mm DASY	28002033	1,200 mm	double asymmetric	92 %	18 pc(s).	0.249 kg
ACL LINEAR LENS 24x1500mm DASY	28002034	1,500 mm	double asymmetric	92 %	18 pc(s).	0.311 kg
ACL LINEAR LENS 24x1800mm DASY	28002035	1,800 mm	double asymmetric	92 %	18 pc(s).	0.373 kg
ACL Endcap LENS 24mm PSF	28002669	-	-	-	3,600 pc(s).	0.003 kg

ACL CLIP 4.3mm

Accessory

**Product description**

- _ Clip for fixation of LED modules with 4.3 mm holes
- _ Fast snap on mounting (sheet thickness 0.5 – 1.0 mm for PUSH-FIX and 1 – 2 mm for PUSH-FIX Long)
- _ For drilling hole 4 mm
- _ Clip made of polycarbonate
- _ Minimum sales quantity 500 pcs.

Website

<http://www.tridonic.com/28001036>

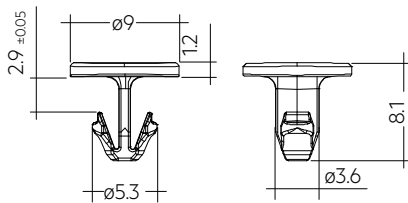
**Ordering data**

Type	Article number	Colour	Packaging, bag ^①	Weight per pc.
ACL CLIP 4.3mm PUSH-FIX	28001036	White	500 pc(s).	0.001 kg
ACL CLIP 4,3mm PUSH-FIX Long	28002314	Transparent	500 pc(s).	0.001 kg

① Minimum sales quantity 500 pcs.

ACL BRIDGE LLE24/40

Accessory

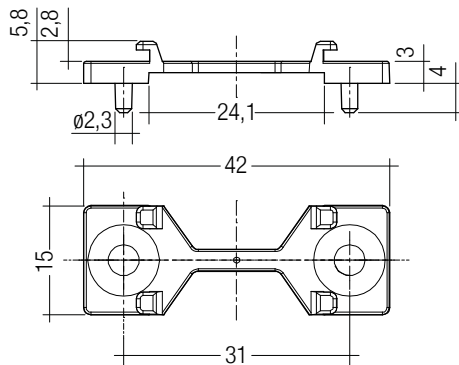
**Product description**

- _ Enables the fixation of 24 mm wide Tridonic LED modules to fixtures made for 40 mm wide modules
- _ Ideal for extruded aluminium gear trays made for 40 mm modules with pre-alignment knobs
- _ Clip-on for LINEAR COVER and LINEAR LENS ^①
- _ For LLE 24 with 280 mm module minimum 2 bridges required
- _ For LLE 24 with 560 mm module minimum 3 bridges required
- _ Fixation via M3 or M4 countersunk screw, max. tightening torque 0.5 Nm
- _ BRIDGE made of white polycarbonate
- _ Minimum sales quantity 600 pcs.

^① Beam characteristics will change due to the elevated fixation (see photometric files for details).

Website

<http://www.tridonic.com/28001205>

**Ordering data**

Type	Article number	Colour	Packaging, carton	Weight per pc.
ACL BRIDGE LLE24/40 SCREW-FIX	28001205	White	600 pc(s).	0.001 kg

1. Standards

IEC 62031
IEC 62471
IEC 61000-4-2
IEC 62778
IEC 61547
UL 8750 (for CLASS2 circuits and dry locations)

1.1 Photometric code

Key for photometric code, e. g. 830 / 349

1 st digit	2 nd + 3 rd digit	4 th digit	5 th digit	6 th digit		
Code	CRI	Colour temperature in Kelvin x 100	MacAdam initial	MacAdam after 25% of the lifetime (max.6000h)		
7	70 – 79				Luminous flux after 25% of the lifetime (max.6000h)	
8	80 – 89				Code	Luminous flux
9	≥90				7	≥ 70 %
			8	≥ 80 %		
			9	≥ 90 %		

1.2 Energy classification

Type	Colour temperature	Forward current	Energy classification	Energy consumption
LLE 24x280mm 2000lm 930 HV ADV5	3,000 K	325 mA	D	11 kWh / 1,000 h
LLE 24x280mm 2000lm 940 HV ADV5	4,000 K	325 mA	D	11 kWh / 1,000 h
LLE 24x560mm 4000lm 930 HV ADV5	3,000 K	325 mA	D	22 kWh / 1,000 h
LLE 24x560mm 4000lm 940 HV ADV5	4,000 K	325 mA	D	22 kWh / 1,000 h

Energy label and further information at www.tridonic.com in the certificates tab of the corresponding product page and at the EPREL data base <https://eprel.ec.europa.eu/>

2. Thermal details

2.1 tc point, ambient temperature and lifetime

The temperature at tp reference point is crucial for the light output and lifetime of a LED product.

For LLE a tp temperature of 65 °C has to be complied in order to achieve an optimum between heat sink requirements, light output and lifetime.

Compliance with the maximum permissible reference temperature at the tc point must be checked under operating conditions in a thermally stable state. The maximum value must be determined under worst-case conditions for the relevant application.

The tc and tp temperature of LED modules from Tridonic are measured at the same reference point.

2.2 Storage and humidity

Storage temperature	-40...+80 °C
---------------------	--------------

Operation only in non condensing environment.

Humidity during processing of the module should be between 30 to 70 %.

2.3 Thermal design and heat sink

The rated life of LED products depends to a large extent on the temperature. If the permissible temperature limits are exceeded, the life of the LLE will be greatly reduced or the LLE may be destroyed.

2.4 Heat sink values

LLE 24x280mm 2000lm ADV5

ta	tp	Forward current	R _{th, hs-a}	Cooling area
25 °C	65 °C	325 mA	7.87 K/W	85 cm ²
25 °C	65 °C	500 mA	4.58 K/W	146 cm ²
35 °C	65 °C	325 mA	5.90 K/W	113 cm ²
35 °C	65 °C	500 mA	3.43 K/W	194 cm ²
45 °C	65 °C	325 mA	3.93 K/W	170 cm ²
45 °C	65 °C	500 mA	2.29 K/W	292 cm ²
55 °C	65 °C	325 mA	1.96 K/W	340 cm ²
55 °C	65 °C	500 mA	1.14 K/W	585 cm ²

LLE 24x560mm 4000lm ADV5

ta	tp	Forward current	R _{th, hs-a}	Cooling area
25 °C	65 °C	325 mA	3.93 K/W	170 cm ²
25 °C	65 °C	500 mA	2.29 K/W	291 cm ²
35 °C	65 °C	325 mA	2.95 K/W	226 cm ²
35 °C	65 °C	500 mA	1.72 K/W	388 cm ²
45 °C	65 °C	325 mA	1.96 K/W	339 cm ²
45 °C	65 °C	500 mA	1.14 K/W	583 cm ²
55 °C	65 °C	325 mA	0.98 K/W	680 cm ²
55 °C	65 °C	500 mA	0.57 K/W	1,169 cm ²

Notes

The actual cooling surface can differ because of the material, the structural shape, outside influences and the installation situation. Depending on the heat sink a heat conducting paste or heat conducting film might be necessary to keep the specified tp temperature.

3. Installation / wiring

3.1 Electrical supply/choice of LED driver

LLE modules from Tridonic are not protected against overvoltages, overcurrents, overloads or short-circuit currents. Safe and reliable operation can only be guaranteed in conjunction with a LED driver which complies with the relevant standards. The use of LED driver from Tridonic in combination with LLE modules guarantees the necessary protection for safe and reliable operation.

If a LED driver other than Tridonic is used, it must provide the following protection:

- Short-circuit protection
- Overload protection
- Overtemperature protection



LLE modules must be supplied by a constant current LED driver. Operation with a constant voltage LED driver will lead to an irreversible damage of the module.

Wrong polarity can damage the LLE.

The LLE module is designed for serial wiring.

With parallel wiring tolerance-related differences in output are possible (thermal stress of the module) and can cause differences in brightness.

If a wire breaks or a complete module fails then the current passing through the other module increases. This may reduce its life considerably.

Max. 8 pieces 280 mm modules or 4 pieces 560 mm modules may be connected in parallel.

LLE can be operated either from SELV LED drivers or from LED drivers with LV output voltage.



LLE are basic insulated up to 320 V (if mounted with M4 screws with head diameter 7 mm in combination with plastic washers) against ground and can be mounted directly on earthed metal parts of the luminaire. If the max. output voltage of the LED driver (also against earth) is above 320 V, an additional insulation between LED module and heat sink is required (for example by insulated thermal pads) or by a suitable luminaire construction.

At voltages > 60 V an additional protection against direct touch (test finger) to the light emitting side of the module has to be guaranteed. This is typically achieved by means of a non removable light distributor over the module.

3.2 Wiring

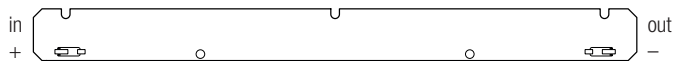

Wiring examples

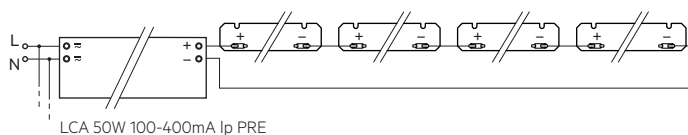

3.3 Wiring type and cross section

For wiring use stranded wire with ferrules or solid wire from 0.2 to 0.75 mm². For the push-wire connection you have to strip the insulation (8–9 mm).

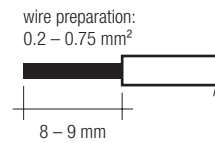

To remove the wires use a suitable tool (e.g. Microcon release pin) or through twist and pull.

3.4 Mounting instruction



None of the components of the LLE (substrate, LED, electronic components etc.) may be exposed to tensile or compressive stresses.

Max. torque for fixing: 0.5 Nm.

The LED modules are mounted onto a heat sink with min. 3 screws per module or ACL CLIP 4.3mm.



Chemical substance may harm the LED module. Chemical reactions could lead to colour shift, reduced luminous flux or a total failure of the module caused by corrosion of electrical connections.

Materials which are used in LED applications (e.g. sealings, adhesives) must not produce dissolver gas. They must not be condensation curing based, acetate curing based or contain sulfur, chlorine or phthalate.

Avoid corrosive atmosphere during usage and storage.

3.5 EOS/ESD safety guidelines



The device / module contains components that are sensitive to electrostatic discharge and may only be installed in the factory and on site if appropriate EOS/ESD protection measures have been taken. No special measures need be taken for devices/modules with enclosed casings (contact with the pc board not possible), just normal installation practice. Please note the requirements set out in the document EOS / ESD guidelines (Guideline_EOS_ESD.pdf) at: <http://www.tridonic.com/esd-protection>

4. Lifetime

4.1 Lifetime, lumen maintenance and failure rate

The light output of an LED module decreases over the lifetime, this is characterized with the L value.

L70 means that the LED module will give 70 % of its initial luminous flux.

This value is always related to the number of operation hours and therefore defines the lifetime of an LED module.

As the L value is a statistical value and the lumen maintenance may vary over the delivered LED modules.

The B value defines the amount of modules which are below the specific L value, e.g. L70B10 means 10 % of the LED modules are below 70 % of the initial luminous flux, respectively 90 % will be above 70 % of the initial value.

In addition the percentage of failed modules (fatal failure) is characterized by the C value.

The F value is the combination of the B and C value. That means for F degradation and complete failures are considered, e.g. L70F10 means 10 % of the LED modules may fail or be below 70 % of the initial luminous flux.

4.2 Lumen maintenance for LLE 24mm HV ADV5

Forward current	tp tempera- ture	L90 / F10	L90 / F50	L80 / F10	L80 / F50	L70 / F10	L70 / F50
150 mA	45 °C	42,000 h	57,000 h	>72,000 h	>72,000 h	>72,000 h	>72,000 h
	50 °C	41,000 h	55,000 h	>72,000 h	>72,000 h	>72,000 h	>72,000 h
	55 °C	40,000 h	54,000 h	>72,000 h	>72,000 h	>72,000 h	>72,000 h
	60 °C	39,000 h	52,000 h	>72,000 h	>72,000 h	>72,000 h	>72,000 h
	65 °C	38,000 h	50,000 h	>72,000 h	>72,000 h	>72,000 h	>72,000 h
	70 °C	38,000 h	49,000 h	>72,000 h	>72,000 h	>72,000 h	>72,000 h
	75 °C	37,000 h	47,000 h	>72,000 h	>72,000 h	>72,000 h	>72,000 h
	80 °C	36,000 h	46,000 h	>72,000 h	>72,000 h	>72,000 h	>72,000 h
	85 °C	35,000 h	45,000 h	>72,000 h	>72,000 h	>72,000 h	>72,000 h
	200 mA	40 °C	43,000 h	58,000 h	>72,000 h	>72,000 h	>72,000 h
45 °C		42,000 h	57,000 h	>72,000 h	>72,000 h	>72,000 h	>72,000 h
50 °C		41,000 h	55,000 h	>72,000 h	>72,000 h	>72,000 h	>72,000 h
55 °C		40,000 h	53,000 h	>72,000 h	>72,000 h	>72,000 h	>72,000 h
60 °C		39,000 h	51,000 h	>72,000 h	>72,000 h	>72,000 h	>72,000 h
65 °C		38,000 h	50,000 h	>72,000 h	>72,000 h	>72,000 h	>72,000 h
70 °C		37,000 h	48,000 h	>72,000 h	>72,000 h	>72,000 h	>72,000 h
75 °C		36,000 h	47,000 h	>72,000 h	>72,000 h	>72,000 h	>72,000 h
80 °C		36,000 h	45,000 h	>72,000 h	>72,000 h	>72,000 h	>72,000 h
85 °C		35,000 h	44,000 h	>72,000 h	>72,000 h	>72,000 h	>72,000 h
300 mA	40 °C	42,000 h	58,000 h	>72,000 h	>72,000 h	>72,000 h	>72,000 h
	45 °C	41,000 h	56,000 h	>72,000 h	>72,000 h	>72,000 h	>72,000 h
	50 °C	40,000 h	54,000 h	>72,000 h	>72,000 h	>72,000 h	>72,000 h
	55 °C	40,000 h	52,000 h	>72,000 h	>72,000 h	>72,000 h	>72,000 h
	60 °C	39,000 h	51,000 h	>72,000 h	>72,000 h	>72,000 h	>72,000 h
	65 °C	38,000 h	49,000 h	>72,000 h	>72,000 h	>72,000 h	>72,000 h
	70 °C	37,000 h	48,000 h	>72,000 h	>72,000 h	>72,000 h	>72,000 h
	75 °C	36,000 h	46,000 h	>72,000 h	>72,000 h	>72,000 h	>72,000 h
	80 °C	35,000 h	45,000 h	>72,000 h	>72,000 h	>72,000 h	>72,000 h
	85 °C	34,000 h	44,000 h	70,000 h	>72,000 h	>72,000 h	>72,000 h
375 mA	40 °C	42,000 h	57,000 h	>72,000 h	>72,000 h	>72,000 h	>72,000 h
	45 °C	41,000 h	55,000 h	>72,000 h	>72,000 h	>72,000 h	>72,000 h
	50 °C	40,000 h	54,000 h	>72,000 h	>72,000 h	>72,000 h	>72,000 h
	55 °C	39,000 h	52,000 h	>72,000 h	>72,000 h	>72,000 h	>72,000 h
	60 °C	38,000 h	50,000 h	>72,000 h	>72,000 h	>72,000 h	>72,000 h
	65 °C	37,000 h	49,000 h	>72,000 h	>72,000 h	>72,000 h	>72,000 h
	70 °C	37,000 h	47,000 h	>72,000 h	>72,000 h	>72,000 h	>72,000 h
	75 °C	36,000 h	46,000 h	>72,000 h	>72,000 h	>72,000 h	>72,000 h
	80 °C	35,000 h	44,000 h	71,000 h	>72,000 h	>72,000 h	>72,000 h
	85 °C	34,000 h	43,000 h	69,000 h	>72,000 h	>72,000 h	>72,000 h

Forward current	tp tempera- ture	L90 / F10	L90 / F50	L80 / F10	L80 / F50	L70 / F10	L70 / F50
450 mA	45 °C	41,000 h	55,000 h	>72,000 h	>72,000 h	>72,000 h	>72,000 h
	50 °C	40,000 h	53,000 h	>72,000 h	>72,000 h	>72,000 h	>72,000 h
	55 °C	39,000 h	51,000 h	>72,000 h	>72,000 h	>72,000 h	>72,000 h
	60 °C	38,000 h	50,000 h	>72,000 h	>72,000 h	>72,000 h	>72,000 h
	65 °C	37,000 h	48,000 h	>72,000 h	>72,000 h	>72,000 h	>72,000 h
	70 °C	36,000 h	47,000 h	>72,000 h	>72,000 h	>72,000 h	>72,000 h
	75 °C	35,000 h	45,000 h	>72,000 h	>72,000 h	>72,000 h	>72,000 h
	80 °C	35,000 h	44,000 h	70,000 h	>72,000 h	>72,000 h	>72,000 h
	85 °C	34,000 h	43,000 h	69,000 h	>72,000 h	>72,000 h	>72,000 h
	500 mA	40 °C	41,000 h	56,000 h	>72,000 h	>72,000 h	>72,000 h
45 °C		40,000 h	54,000 h	>72,000 h	>72,000 h	>72,000 h	>72,000 h
50 °C		39,000 h	52,000 h	>72,000 h	>72,000 h	>72,000 h	>72,000 h
55 °C		38,000 h	51,000 h	>72,000 h	>72,000 h	>72,000 h	>72,000 h
60 °C		38,000 h	49,000 h	>72,000 h	>72,000 h	>72,000 h	>72,000 h
65 °C		37,000 h	48,000 h	>72,000 h	>72,000 h	>72,000 h	>72,000 h
70 °C		36,000 h	46,000 h	>72,000 h	>72,000 h	>72,000 h	>72,000 h
75 °C		35,000 h	45,000 h	71,000 h	>72,000 h	>72,000 h	>72,000 h
80 °C		34,000 h	43,000 h	70,000 h	>72,000 h	>72,000 h	>72,000 h
85 °C		34,000 h	42,000 h	68,000 h	>72,000 h	>72,000 h	>72,000 h

4.3 Switching capability

100,000 cycles

Tridonic test according to IEC 62717 Cl 10.3.3
30 s on / 30 s off at I_{max}

5. Electrical values

5.1 Declaration of electrical parameters

Irated ... Nominal operating current the module is designed for.

I_{max} ... Max. permissible continuous operating current incl. The tolerances of the LED driver.

Max. permissible LF current ripple ... Max. output current of the LED driver incl. Tolerances and LF current ripple must not exceed this value.

Max. permissible peak current ... The max. output peak current of the LED driver must not exceed this value.

5.2 Typ. forward voltage vs. forward current

LLE 24x280mm 2000lm 9xx HV ADV5

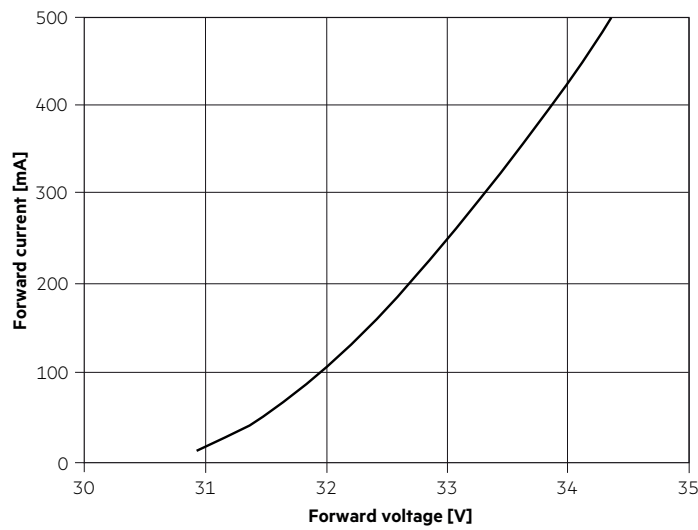

LLE 24x560mm 4000lm 9xx HV ADV5

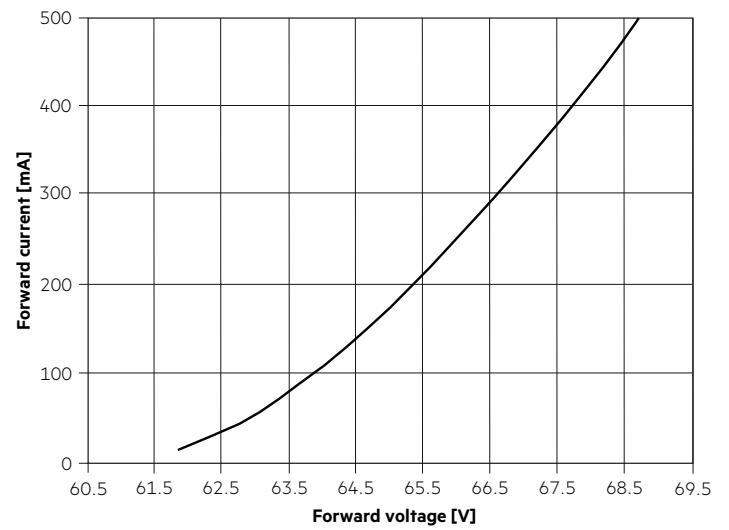

The diagrams are based on statistic values.
The real values can be different.

5.3 Forward voltage vs. tc temperature

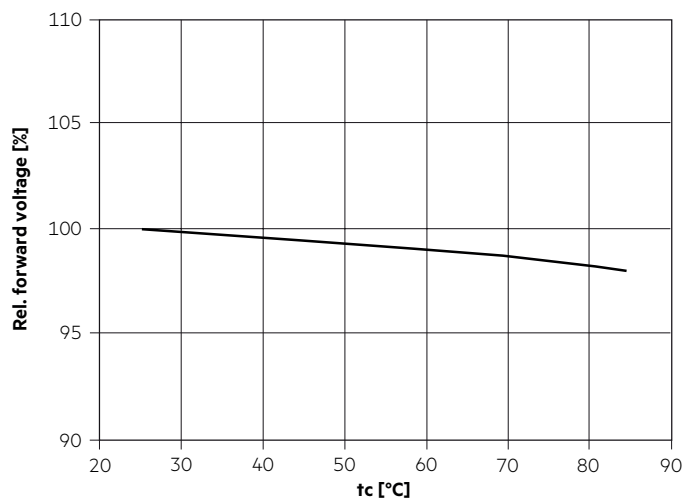

The diagrams are based on statistic values.
The real values can be different.

6. Photometric characteristics

6.1 Coordinates and tolerances according to CIE 1931

The specified colour coordinates are integral measured by current impulse of 195 mA and a duration of 100 ms.
 The ambient temperature of the measurement is $t_a = 25^\circ\text{C}$.
 The measurement tolerance of the colour coordinates are ± 0.01 .

3,000 K

	x0	y0
Centre	0.4338	0.4030

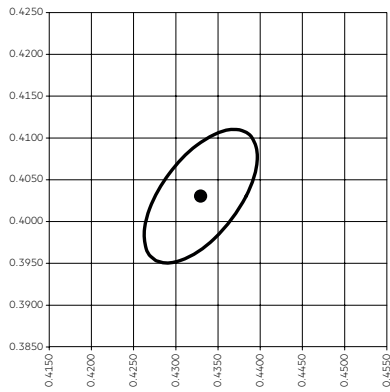

— MacAdam Ellipse: 3SDCM

TM30		CRI	
Rf	Rg	Ra	R9
90	98	92	57

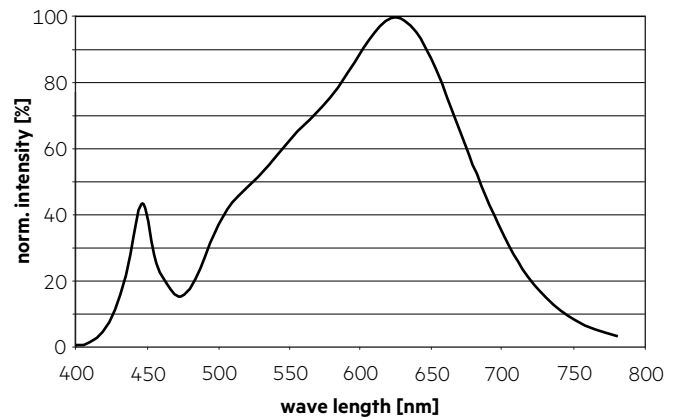

Colour vector graphic

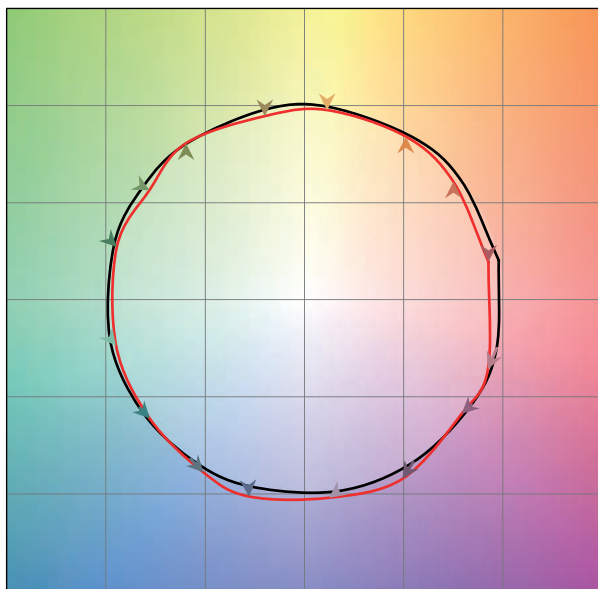

— Reference source
 — Test source

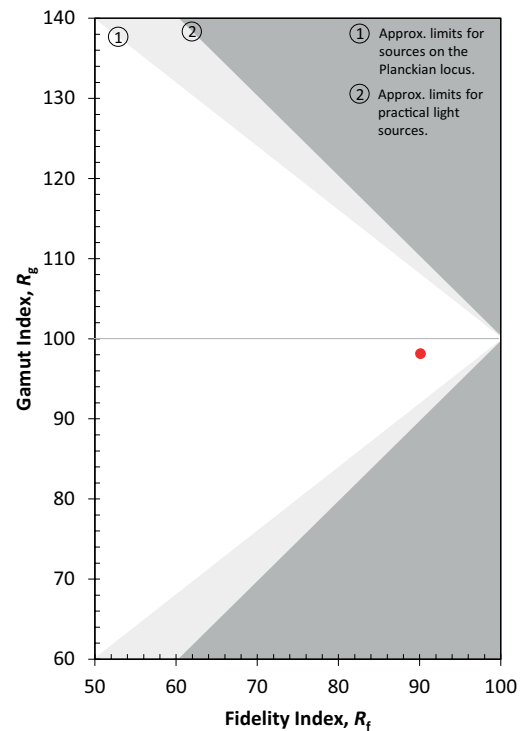

4,000 K

	x0	y0
Center	0.3818	0.3797

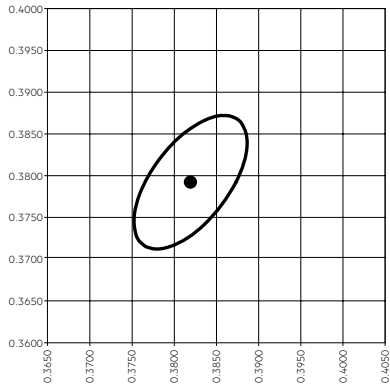

— MacAdam Ellipse: 3SDCM

TM30		CRI	
Rf	Rg	Ra	R9
89	99	91	54

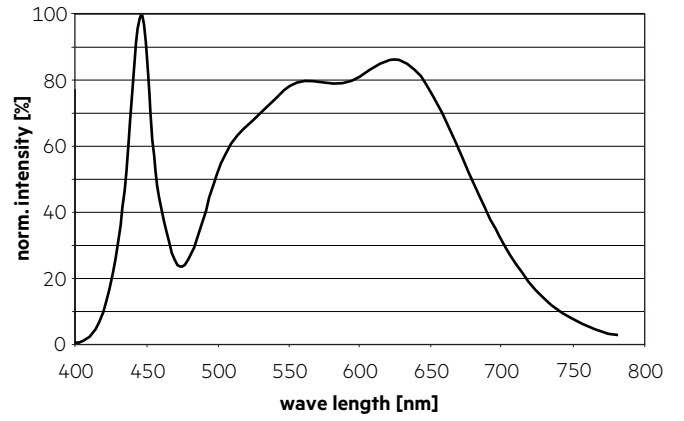

Colour vector graphic

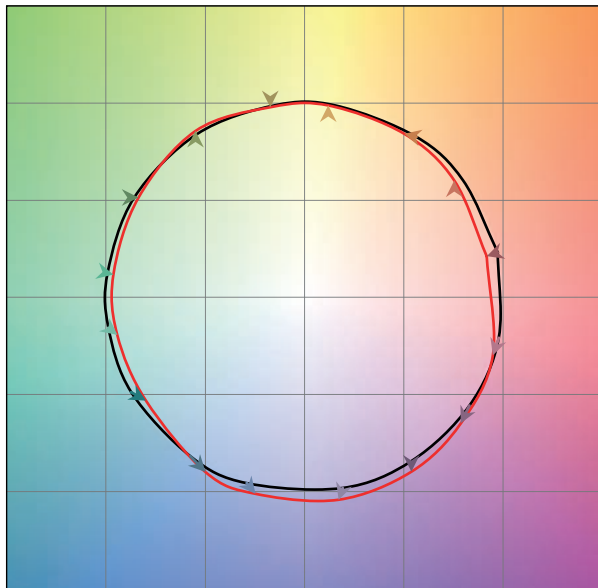

— Reference source
— Test source

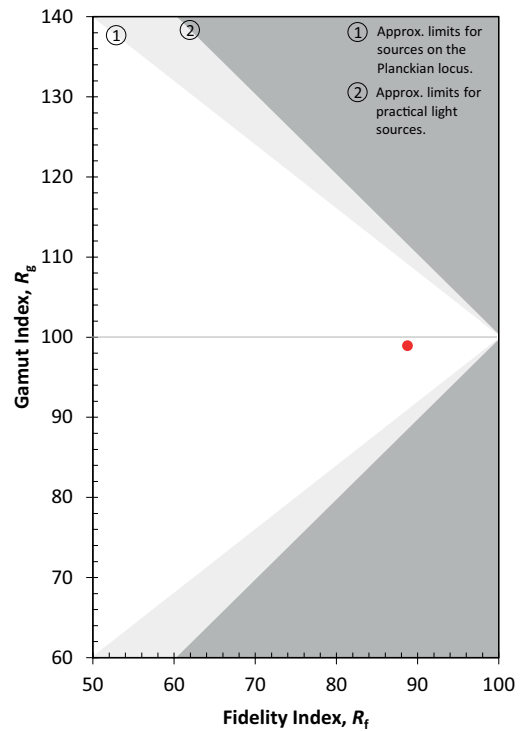

6.2 Light distribution

The optical design of the LLE product line ensures optimum homogeneity for the light distribution.

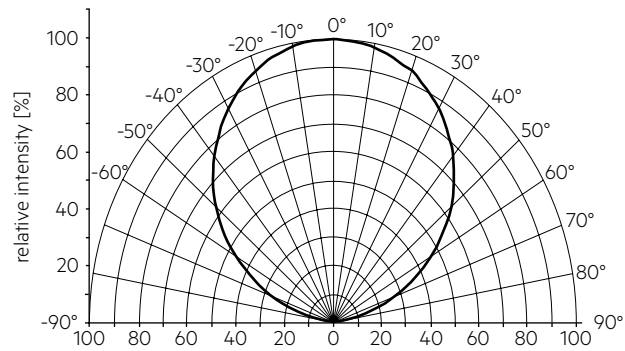

The colour temperature is measured integral over the complete module. The single LED light points can have deviations in the colour coordinates within MacAdam 5.

To ensure an ideal mixture of colours and a homogeneous light distribution a suitable optic (e. g. PMMA diffuser) and a sufficient spacing between module and optic (typ. 4 cm) should be used.

6.3 Relative luminous flux vs. tc temperature

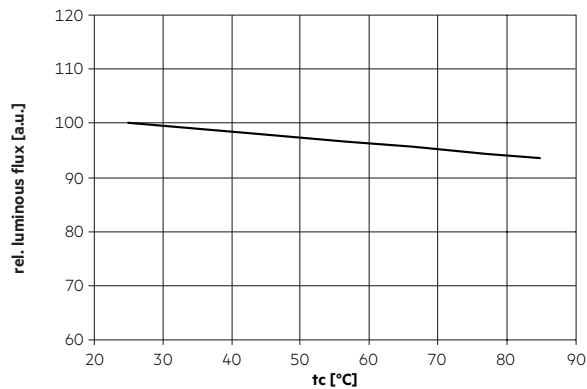

6.4 Relative luminous flux vs. operating current

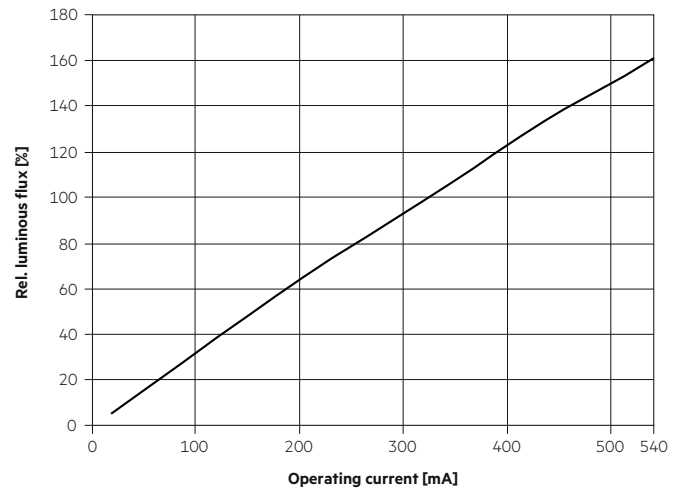

The diagrams are based on statistic values.
The real values can be different.

7. Miscellaneous

7.1 Additional information

Additional technical information at www.tridonic.com → Technical Data

Guarantee conditions at www.tridonic.com → Services

Lifetime declarations are informative and represent no warranty claim.