

EM MINI BASIC, 220 – 240 V 50/60 Hz BASIC version

Product description

- Emergency lighting supply unit for manual testing
- For compact fluorescent lamps
- Small dimensions (28 x 40 mm cross-section, 150 mm length)
- 5-year guarantee

Properties

- 3 h rated duration
- Compatible with all electronic ballasts (dimnable and non-dimnable)
- Can also be used in combination with conventional magnetic ballasts
- 5-pole technology: 4-pole lamp changeover and delayed power switching for the ballast
- Switchover relay with high-current contacts
- IDC (insulation displacement connection)
- Green charge status display LED
- Checking the emergency lighting function by interrupting the unswitched phase
- Deep discharge protection
- Short-circuit-proof battery connection
- Polarity reversal protection for battery



Batteries

- High-temperature cells
- NiCd batteries
- D cells
- Blade terminals for simple connection
- 4-year design life
- 1-year guarantee
- For battery compatibility refer to chapter „Ballast-Lumen-Factor (BLF)“



Standards, page 5

Wiring diagrams and installation examples, page 7 and 8



EM MINI BASIC, 220 – 240 V 50/60 Hz BASIC version

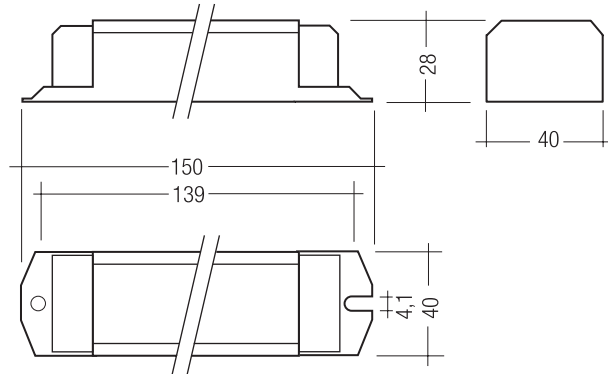

Technical data

Rated supply voltage	220 – 240 V
Mains frequency	50 / 60 Hz
Mains current	0.03 A
Rated power	3.9 W
Battery charging time	24 h
Discharge current ^①	11 A
Charge current ^①	210 mA
Leakage current (PE)	0.5 mA
Ambient temperature t_a	0 ... +60 °C
Max. casing temperature t_c	70 °C
Mains voltage changeover threshold	according to EN 60598-2-22
Min. lamp starting temperature (emergency mode)	0 °C
Type of protection	IP20

Ordering data

Type	Article number	Number of cells	Packaging, carton	Packaging, pallet	Weight per pc.
Rated operating time 3 h					
EM 33A MINI BASIC	89899951	3	25 pc(s).	1,000 pc(s).	0.155 kg
EM 34A MINI BASIC	89899950	4	25 pc(s).	1,000 pc(s).	0.155 kg
EM 34C MINI BASIC	89899952	4	25 pc(s).	1,000 pc(s).	0.155 kg

^① Tolerance ± 15 % at 230 V

RoHS

ACCESSORIES

Status indication green LED

Product description

- A green LED indicates that charging current is flowing into the battery



Ordering data

Type	Article number	Packaging, bag	Packaging, carton	Weight per pc.
LED EM green	89899605	25 pc(s).	200 pc(s).	0.011 kg
LED EM green, ultra high brightness	89899756	25 pc(s).	800 pc(s).	0.012 kg

Ballast lumen factor (BLF) in %

EM MINI BASIC for compact lamps, 3 h

		3 h	3 cells	4 cells	
		Type	EM 33A MINI BASIC	EM 34A MINI BASIC	EM 34C MINI BASIC
		Article no.	89899951	89899950	89899952
Lamp type	Wattage	BLF in emergency lighting mode in % for rated operating time			
TC-DD	28 W	9			
	38 W				6.5
TC-F	36 W		11.5		
TC-DEL	18 W		16.5		
	26 W		13		
TC-TEL	18 W		16.5		
	26 W		13		
T5c	22 W		16		

Technology and capacity	Design	Number of cells	Typ	Article number	Assignable batteries		
NiCd 4 Ah D-cells	Stick	3	Accu-NiCd 3A	89895960	•		
	side by side	3	Accu-NiCd 3B 55	89800384	•		
	Stick	4	Accu-NiCd 4A 55	89800089		•	•
	side by side	4	Accu-NiCd 4B 55	89800385		•	•
	Stick + Stick	2 + 2	Accu-NiCd 4C	89895978		•	•
Accupack NiCd (high temperature)	Accupack 4.5 Ah	3	Pack-NiCd 3D CON	89800389	•		
	Accupack 4.5 Ah	4	Pack-NiCd 4D CON	89800390		•	•

Emergency Ballast lumen factor (EBLF) in %

EM MINI BASIC, 3 h

	3 h	3 cells		4 cells	
	Type	EM 33A MINI BASIC	EM 34A MINI BASIC	EM 34C MINI BASIC	
	Article no.	89899951	89899950	89899952	
Lamp type	Wattage				
TC-DD	28 W	9,4			
	38 W				5,3
TC-F	36 W		10,9		
TC-DEL	18 W		18,7		
	26 W		14,1		
TC-TEL	18 W		18,7		
	16 W		14,1		
T5c	22 W		15,3		

Standards

- according to EN 50172
- according to EN 60598-2-22
- EN 601347-2-7
- EN 55015
- EN 61000-3-2
- EN 61000-3-3
- EN 61547
- EN 60068-2-64
- EN 60068-2-29
- EN 60068-2-30

Note

The EM Mini Basic is not intended to be used for high risk task area lighting.

Isolation and electric strength testing of luminaires

Electronic devices can be damaged by high voltage. This has to be considered during the routine testing of the luminaires in production.

According to IEC 60598-1 Annex Q (informative only!) or ENEC 303-Annex A, each luminaire should be submitted to an isolation test with 500 VDC for 1 second. This test voltage should be connected between the interconnected phase and neutral terminals and the earth terminal. The isolation resistance must be at least 2 MΩ.

As an alternative, IEC 60598-1 Annex Q describes a test of the electrical strength with 1,500 VAC (or 1,414 x 1,500 VDC). To avoid damage to the electronic devices this test must not be conducted.

Basic insulation between supply and battery circuit.

Lamp current in emergency operation in mA

EM MINI BASIC, 3 h

	3 h	3 cells		4 cells	
	Type	EM 33A MINI BASIC	EM 34A MINI BASIC	EM 34C MINI BASIC	
	Article no.	89899951	89899950	89899952	
Lamp type	Wattage				
TC-DD	28 W	17			
	38 W				12
TC-F	36 W		27		
TC-DEL	18 W		28		
	26 W		28		
TC-TEL	18 W		28		
	16 W		28		
T5c	22 W		27		

Battery discharge current in Ampere [A]

EM MINI BASIC, 3 h

	3 h	3 cells		4 cells	
	Type	EM 33A MINI BASIC	EM 34A MINI BASIC	EM 34C MINI BASIC	
	Article no.	89899951	89899950	89899952	
Lamp type	Wattage				
TC-DD	28 W				
	38 W				
TC-F	36 W				
TC-DEL	18 W				
	26 W				
TC-TEL	18 W				
	16 W				
T5c	22 W				

Notes:

- Tolerance ± 15 % at 230 V
- Low battery voltage cut off (LBVCO) = 0.8 V per cell

Technical data batteries**Accu-NiCd****4.2 / 4.5 Ah**

Battery voltage/cell	1.2 V
Cell type	D
Case temperature range	
to ensure 4 years design life	+5 °C to +55 °C
Max. short term temperature (reduced life-time)	70 °C
Max. number discharge cycles	4 cycles per year plus 4 cycles during comissioning
Max. storage time	6 months

Akkupack-NiCd**4.5 Ah**

Battery voltage/cell	1.2 V
Cell type	D
Case temperature range	
(to ensure a 4 years design life)	+5 °C to +55 °C
Max. short term temperature (reduced life-time)	70 °C
Max. number discharge cycles	4 cycles per year plus 4 cycles during comissioning
Max. storage time	6 months

For further informations refer to corresponding battery datasheet.

Storage, installation and commissioning

Relevant information about storage conditions, installation and commissioning are provided in the battery datasheets.

Note:

Care should be taken to ensure batteries and emergency units don't exceed their maximum temperatures.

Connection method: 4.8 x 0.5 mm spade welded to end of cell.

For the stick batteries this connection is accessible after the battery end caps have been fitted.

To inhibit inverter operation, only disconnect the batteries by removing the connector from the battery spade tags.

Note

The battery charger of the EM MINI BASIC is short circuit protected. After a battery short circuit the protection device will be resetted after a short while. Battery must not be connected to earth.

Working voltage (U_{out})

Type	U _{out} [®]
EM 33A MINI BASIC	250 / 250 V
EM 34A MINI BASIC	250 / 250 V
EM 34C MINI BASIC	250 / 250 V

[®] Max. voltage between output terminals / Max. voltage between output terminal to earth

Electrical connections

An earthed starting aid is recommended. The module should be earthed by the fixings used to attach it to the luminaire.

Terminal block type:

Push wire and insulation displacement

Terminal block capacity:

- Push wire: 0.5 to 1.5 mm² solid conductor
- Insulation displacement: 0.5 mm² solid conductor

Wire strip length: 7.5 to 8.5 mm

EM MINI BASIC leads 5, 6 max. 0.5 m (< 50 pF)

EM MINI BASIC leads 3, 4 max. 1.0 m (< 100 pF)



Care should be taken not to exceed the total maximum lamp lead capacitance for HF ballast.

Leads should always be kept as short as possible.

Mechanical details

Channel manufactured from 0.4 mm galvatite galvanised steel.

Cover manufactured from 0.4 mm white precoated steel.

LED charge indicator:

- Green
- Mounting hole 6.5 mm dia
- Length of LED lead 750 mm (Bezel supplied fitted to LED)
- Insulation temperature rating: 90 °C

Battery leads:

- Quantity: 1 red and 1 black
- Length: 1000 mm (Accu NiCd 3B, 4B, 4C), 1300 mm (all others)
- Wire type: 0.5 mm² solid conductor
- Insulation temperature rating: 90 °C

Termination 1:

Push on 4.8 mm receptacle to suit
battery spade fitted with insulating cover

Termination 2:

9 mm stripped insulation

Two-piece batteries are supplied with a 200 mm lead with 4.8 mm receptacles at each end and insulating covers to connect the separate sticks together.

Life-time

Average life-time 50,000 h under rated conditions with a failure rate less than 10 %. Average failure rate of 0.2 % per 1,000 operating hours.

Wiring guidelines

To ensure that a luminaire containing high frequency emergency units complies with EN 55015 for radio frequency conducted interference in both normal and emergency mode it is essential to follow good practice in the wiring layout.

Within the luminaire the switched and unswitched 50 Hz supply wiring must be routed as short as possible and be kept as far away as possible from the lamp leads.

This means, for example, in a linear T8 or T5 luminaire the mains wiring should be routed along one side of the luminaire body, while the wires to the emergency lamp from the emergency module are routed along the other side.

The high frequency emergency lamp wiring contains “hot” leads at pins 1 and 6, which have high voltage to earth. These should be kept as short as possible and separated from other wiring to minimize coupling. They also have a

restriction on capacitance to other wiring and earth of 100 pF, which must be observed to ensure good lamp starting.

With an earth connection of the metal case of the emergency module the noise suppression can be further improved. The wiring of the earth should be kept as short as possible.

Through wiring may affect the emc performance of the luminaire.

With the use of the fifth pole possible compatibility problems between the products can be prevented. Depending on the luminaire wiring the radio suppression in the emergency mode of operation can be further improved.

Capacitive loading limits of lamp leads must not be exceeded. Note the capacitance of the emergency lamp leads adds to the capacitance of the leads from the ballast to the EM MINI BASIC module when considering ballast loading.

Wiring diagrams

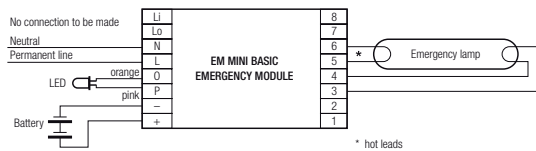

Non maintained

Wiring diagrams for high frequency electronic ballasts

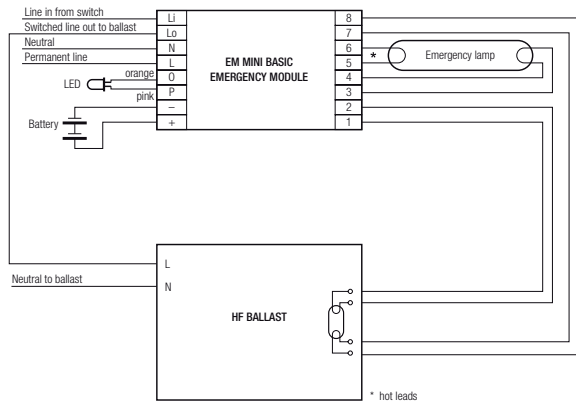

Single lamp high frequency electronic ballast

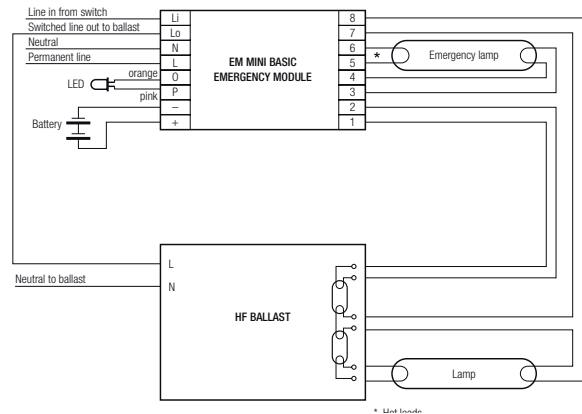

Twin lamp high frequency electronic ballast (6 lamp lead connections)

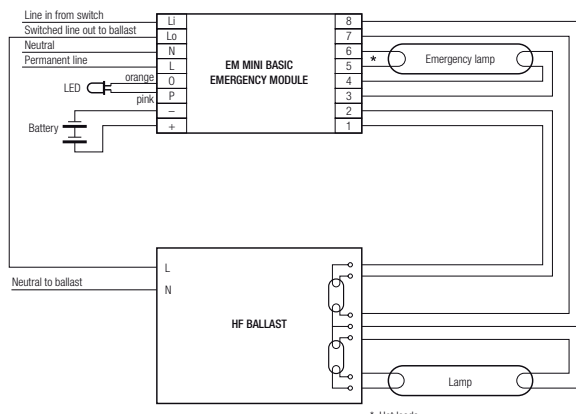

Twin lamp high frequency electronic ballast (7 lamp lead connections)

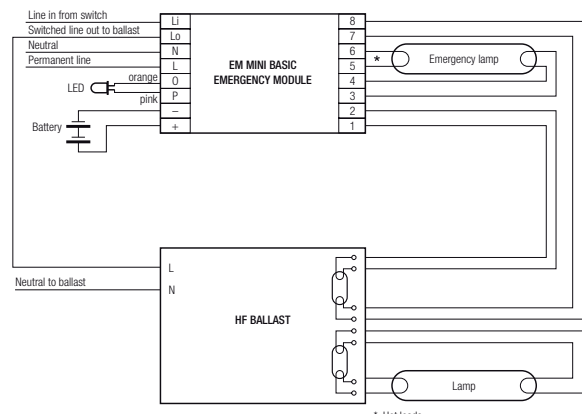

Twin lamp high frequency electronic ballast (8 lamp lead connections)

Wiring diagrams for switch start circuits with magnetic control gear

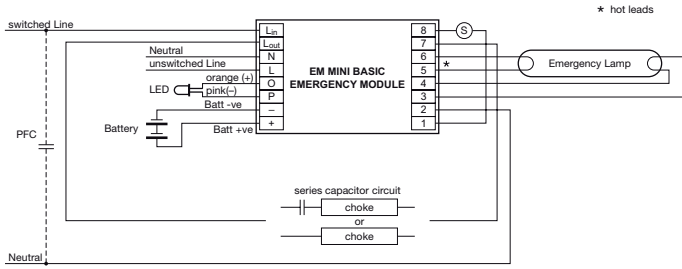

Single lamp switch start circuit with separate lamp holder and starter holder

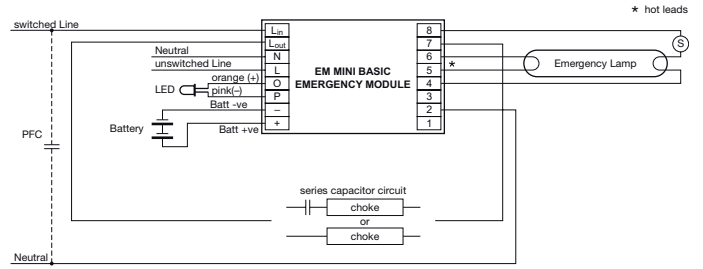

Single lamp switch start circuit with combined lamp holder and starter holder assembly

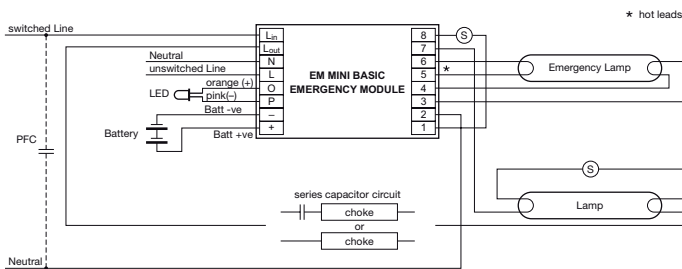

Twin series switch start circuit with separate lamp holder and starter holder

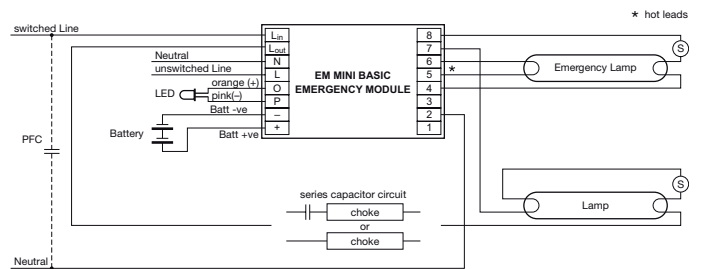

Twin series switch start circuit with combined lamp holder and starter holder assembly

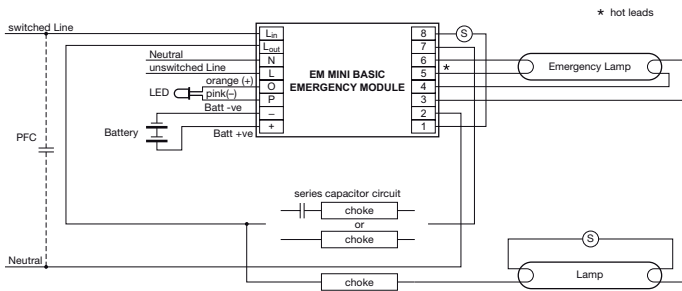

Twin parallel switch start circuit with separate lamp holder and starter holder

Additional information

Additional technical information at www.tridonic.com → Technical Data

Guarantee conditions at www.tridonic.com → Services

Life-time declarations are informative and represent no warranty claim.
No warranty if device was opened.