

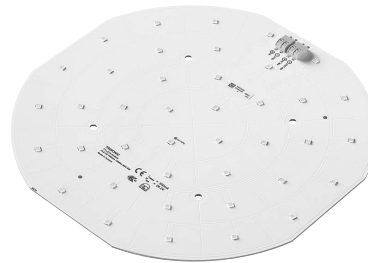

Module CLE 220mm 1500lm ADV EM, CLE 315mm 4000lm ADV EM
Modules CLE

Product description

- Ideal for ceiling-mounted and wallmounted luminaires
- LED system solution consisting of the LED module, the control gear with integrated emergency function and SWITCH sensor
- Based on circular and TC-DD fluorescent lamps
- Efficacy of the module up to 147 lm/W
- SO version is compatible with SWITCH Sensor HF 5BP
- Integrated separate emergency LEDs controlled by EM powerLED
- High colour rendering index CRI > 80
- Small colour tolerance MacAdam 3[®]
- Small luminous flux tolerances
- Colour temperatures 3,000 and 4,000 K
- Push terminals for quick and simple wiring
- Simple installation (e.g. screws)
- Self-cooling (no additional heat sink required)
- Long life-time: 50,000 hours
- 5-year guarantee
- CLE 220: Round Shape enabling a bigger LED area for a better spread of light (by keeping the same position of mounting holes)



CLE G2 220mm 1500lm EM ADV

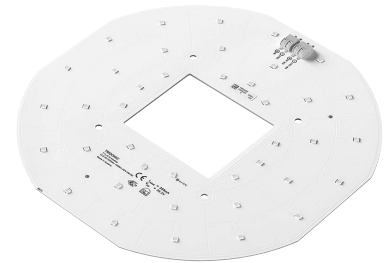

CLE G2 220mm 1500lm EM SO ADV



CLE G2 315mm 4000lm EM ADV

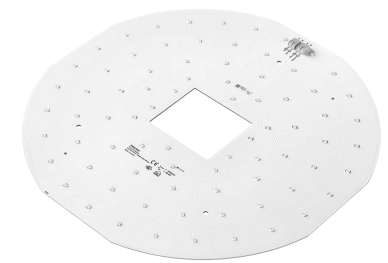

CLE G2 315mm 4000lm EM SO ADV



Standards, page 3

For colour temperatures and tolerances, page 6



Typical application



Module CLE 220mm 1500lm ADV EM, CLE 315mm 4000lm ADV EM

Modules CLE

Technical data

Beam characteristic	120°
Ambient temperature range	-25 ... +45 °C
tp rated	65 °C
tc	85 °C
Max. DC forward current for CLE G2 220mm	720 mA
Max. DC forward current for CLE G2 315mm	1,440 mA
Max. permissible LF current ripple for CLE G2 220mm	792 mA
Max. permissible LF current ripple for CLE G2 315mm	1,584 mA
Max. permissible peak current for CLE G2 220mm	960 mA / max. 10 ms
Max. permissible peak current for CLE G2 315mm	1,920 mA / max. 10 ms
Max. permissible output voltage of LED Driver [®]	300 V
Insulation test voltage	16 kV
ESD classification	severity level 4
Risk group (EN 62471:2008)	1
Type of protection	IP00

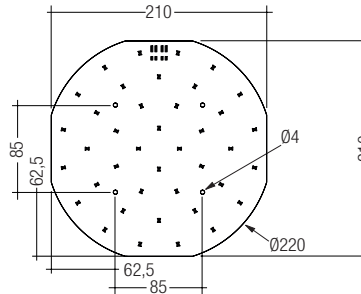

CLE G2 220mm 1500lm EM ADV

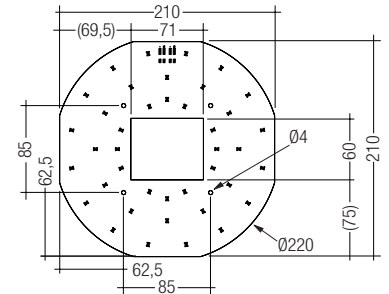

CLE G2 220mm 1500lm EM SO ADV

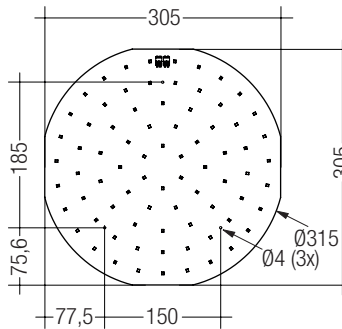

CLE G2 315mm 4000lm EM ADV

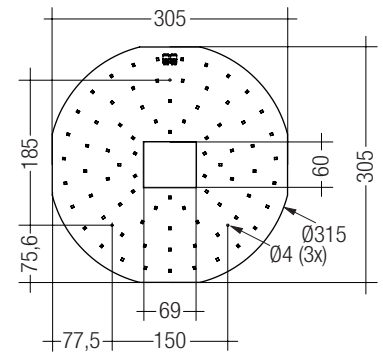

CLE G2 315mm 4000lm EM SO ADV

Ordering data

Type	Article number	Colour temperature	Packaging, carton	Weight per pc.
CLE G2 220mm 1500lm 830 ADV EM	89602097	3,000 K	50 pc(s).	0.101 kg
CLE G2 220mm 1500lm 840 ADV EM	89602098	4,000 K	50 pc(s).	0.101 kg
CLE G2 220mm 1500lm 830 ADV EM SO	89602099	3,000 K	50 pc(s).	0.090 kg
CLE G2 220mm 1500lm 840 ADV EM SO	89602100	4,000 K	50 pc(s).	0.090 kg
CLE G2 315mm 4000lm 830 ADV EM	89602101	3,000 K	10 pc(s).	0.207 kg
CLE G2 315mm 4000lm 840 ADV EM	89602102	4,000 K	10 pc(s).	0.207 kg
CLE G2 315mm 4000lm 830 ADV EM SO	89602103	3,000 K	10 pc(s).	0.197 kg
CLE G2 315mm 4000lm 840 ADV EM SO	89602104	4,000 K	10 pc(s).	0.197 kg

Specific technical data

Type [®]	Photo-metric code	Typ. luminous flux at tp = 25 °C [®]	Typ. luminous flux at tp = 65 °C [®]	Typ. forward current	Min. forward voltage at tp = 65 °C	Max. forward voltage at tp = 25 °C	Typ. power consumption at tp = 65 °C [®]	Luminous efficacy module at tp = 25 °C	Luminous efficacy module at tp = 65 °C	Luminous efficacy system at tp = 65 °C	Colour rendering index CRI	Energy classification
CLE G2 220mm – Operating mode HE												
CLE G2 220mm 1500lm 830 ADV EM	830/349	1,370 lm	1,300 lm	350 mA	25.0 V	28.4 V	9.2 W	146 lm/W	141 lm/W	127 lm/W	> 80	A++
CLE G2 220mm 1500lm 840 ADV EM	840/349	1,490 lm	1,420 lm	350 mA	25.0 V	28.4 V	9.2 W	159 lm/W	154 lm/W	139 lm/W	> 80	A++
CLE G2 220mm 1500lm 830 ADV EM SO	830/349	1,370 lm	1,300 lm	350 mA	25.0 V	28.4 V	9.2 W	146 lm/W	141 lm/W	127 lm/W	> 80	A++
CLE G2 220mm 1500lm 840 ADV EM SO	840/349	1,490 lm	1,420 lm	350 mA	25.0 V	28.4 V	9.2 W	159 lm/W	154 lm/W	139 lm/W	> 80	A++
CLE G2 220mm – Operating mode HO												
CLE G2 220mm 1500lm 830 ADV EM	830/349	1,880 lm	1,790 lm	500 mA	27.1 V	30.8 V	13.8 W	132 lm/W	130 lm/W	117 lm/W	> 80	A+
CLE G2 220mm 1500lm 840 ADV EM	840/349	2,050 lm	1,950 lm	500 mA	27.1 V	30.8 V	13.8 W	144 lm/W	141 lm/W	127 lm/W	> 80	A++
CLE G2 220mm 1500lm 830 ADV EM SO	830/349	1,880 lm	1,790 lm	500 mA	27.1 V	30.8 V	13.8 W	132 lm/W	130 lm/W	117 lm/W	> 80	A+
CLE G2 220mm 1500lm 840 ADV EM SO	840/349	2,050 lm	1,950 lm	500 mA	27.1 V	30.8 V	13.8 W	144 lm/W	141 lm/W	127 lm/W	> 80	A++
CLE G2 220mm – Emergency mode at 320 mA (EM powerLED NM 1 W BASIC, EM powerLED 15 W BASIC CLE NiCd)												
CLE G2 220mm 1500lm 830 ADV EM	830/349	145 lm	140 lm	320 mA	–	–	–	–	–	–	> 80	–
CLE G2 220mm 1500lm 840 ADV EM	840/349	150 lm	145 lm	320 mA	–	–	–	–	–	–	> 80	–
CLE G2 220mm 1500lm 830 ADV EM SO	830/349	145 lm	140 lm	320 mA	–	–	–	–	–	–	> 80	–
CLE G2 220mm 1500lm 840 ADV EM SO	840/349	150 lm	145 lm	320 mA	–	–	–	–	–	–	> 80	–
CLE G2 220mm – Emergency operation at 350 mA (EM powerLED 1 W)												
CLE G2 220mm 1500lm 830 ADV EM	830/349	155 lm	150 lm	350 mA	–	–	–	–	–	–	> 80	–
CLE G2 220mm 1500lm 840 ADV EM	840/349	165 lm	155 lm	350 mA	–	–	–	–	–	–	> 80	–
CLE G2 220mm 1500lm 830 ADV EM SO	830/349	155 lm	150 lm	350 mA	–	–	–	–	–	–	> 80	–
CLE G2 220mm 1500lm 840 ADV EM SO	840/349	165 lm	155 lm	350 mA	–	–	–	–	–	–	> 80	–
CLE G2 220mm – Emergency operation at 400 mA (EM powerLED 15 W BASIC CLE NiMH)												
CLE G2 220mm 1500lm 830 ADV EM	830/349	170 lm	160 lm	400 mA	–	–	–	–	–	–	> 80	–
CLE G2 220mm 1500lm 840 ADV EM	840/349	185 lm	175 lm	400 mA	–	–	–	–	–	–	> 80	–
CLE G2 220mm 1500lm 830 ADV EM SO	830/349	170 lm	160 lm	400 mA	–	–	–	–	–	–	> 80	–
CLE G2 220mm 1500lm 840 ADV EM SO	840/349	185 lm	175 lm	400 mA	–	–	–	–	–	–	> 80	–
CLE G2 220mm – Emergency operation at 600 mA (EM powerLED 2 W)												
CLE G2 220mm 1500lm 830 ADV EM	830/349	250 lm	230 lm	600 mA	–	–	–	–	–	–	> 80	–
CLE G2 220mm 1500lm 840 ADV EM	840/349	270 lm	255 lm	600 mA	–	–	–	–	–	–	> 80	–
CLE G2 220mm 1500lm 830 ADV EM SO	830/349	250 lm	230 lm	600 mA	–	–	–	–	–	–	> 80	–
CLE G2 220mm 1500lm 840 ADV EM SO	840/349	270 lm	255 lm	600 mA	–	–	–	–	–	–	> 80	–
CLE G2 315mm – Operating mode HE												
CLE G2 315mm 4000lm 830 ADV EM	830/349	2,740 lm	2,600 lm	700 mA	25.0 V	28.5 V	18.3 W	145 lm/W	142 lm/W	128 lm/W	> 80	A++
CLE G2 315mm 4000lm 840 ADV EM	840/349	2,990 lm	2,840 lm	700 mA	25.0 V	28.5 V	18.3 W	158 lm/W	155 lm/W	140 lm/W	> 80	A++
CLE G2 315mm 4000lm 830 ADV EM SO	830/349	2,740 lm	2,600 lm	700 mA	25.0 V	28.5 V	18.3 W	145 lm/W	142 lm/W	128 lm/W	> 80	A++
CLE G2 315mm 4000lm 840 ADV EM SO	840/349	2,990 lm	2,840 lm	700 mA	25.0 V	28.5 V	18.3 W	158 lm/W	155 lm/W	140 lm/W	> 80	A++
CLE G2 315mm – Operating mode HO												
CLE G2 315mm 4000lm 830 ADV EM	830/349	3,950 lm	3,750 lm	1,050 mA	27.3 V	31.0 V	29.2 W	131 lm/W	128 lm/W	116 lm/W	> 80	A+
CLE G2 315mm 4000lm 840 ADV EM	840/349	4,310 lm	4,090 lm	1,050 mA	27.3 V	31.0 V	29.2 W	143 lm/W	140 lm/W	126 lm/W	> 80	A++
CLE G2 315mm 4000lm 830 ADV EM SO	830/349	3,950 lm	3,750 lm	1,050 mA	27.3 V	31.0 V	29.2 W	131 lm/W	128 lm/W	116 lm/W	> 80	A+
CLE G2 315mm 4000lm 840 ADV EM SO	840/349	4,310 lm	4,090 lm	1,050 mA	27.3 V	31.0 V	29.2 W	143 lm/W	140 lm/W	126 lm/W	> 80	A++
CLE G2 315mm – Emergency operation at 600 mA (EM powerLED 2 W)												
CLE G2 315mm 4000lm 830 ADV EM	830/349	255 lm	240 lm	600 mA	–	–	–	–	–	–	> 80	–
CLE G2 315mm 4000lm 840 ADV EM	840/349	280 lm	265 lm	600 mA	–	–	–	–	–	–	> 80	–
CLE G2 315mm 4000lm 830 ADV EM SO	830/349	255 lm	240 lm	600 mA	–	–	–	–	–	–	> 80	–
CLE G2 315mm 4000lm 840 ADV EM SO	840/349	280 lm	265 lm	600 mA	–	–	–	–	–	–	> 80	–
CLE G2 315mm – Emergency operation at 1,000 mA (EM powerLED 4 W)												
CLE G2 315mm 4000lm 830 ADV EM	830/349	410 lm	390 lm	1,000 mA	–	–	–	–	–	–	> 80	–
CLE G2 315mm 4000lm 840 ADV EM	840/349	450 lm	425 lm	1,000 mA	–	–	–	–	–	–	> 80	–
CLE G2 315mm 4000lm 830 ADV EM SO	830/349	410 lm	390 lm	1,000 mA	–	–	–	–	–	–	> 80	–
CLE G2 315mm 4000lm 840 ADV EM SO	840/349	450 lm	425 lm	1,000 mA	–	–	–	–	–	–	> 80	–

[®] Tolerance range for optical and electrical data: ±10 %.

[®] If mounted with M4 screws and plastic washers.

[®] Integrated measurement over the whole module.

[®] HE ... high efficiency, HO ... high output.

1. Standards

IEC 62031
IEC 62471
IEC 61000-4-2
IEC 62717

1.1 Photometric code

Key for photometric code, e. g. 830 / 449

1 st digit	2 nd + 3 rd digit	4 th digit	5 th digit	6 th digit	
Code CRI	Colour temperature in Kelvin x 100	McAdam initial	McAdam after 25% of the life-time (max.6000h)	Luminous flux after 25% of the life-time (max.6000h)	
7 70 – 79				Code	Luminous flux
8 80 – 89				7	≥ 70 %
9 ≥90				8	≥ 80 %
				9	≥ 90 %

1.2 Energy classification

Type	Forward current	Energy classification
CLE G2 220mm 1500lm 830 ADV EM	350 mA	A++
	500 mA	A+
CLE G2 220mm 1500lm 840 ADV EM	350 mA	A++
	500 mA	A++
CLE G2 220mm 1500lm 830 ADV EM SO	350 mA	A++
	500 mA	A+
CLE G2 220mm 1500lm 840 ADV EM SO	350 mA	A++
	500 mA	A++
CLE G2 315mm 4000lm 830 ADV EM	700 mA	A++
	1,050 mA	A+
CLE G2 315mm 4000lm 840 ADV EM	700 mA	A++
	1,050 mA	A++
CLE G2 315mm 4000lm 830 ADV EM SO	700 mA	A++
	1,050 mA	A+
CLE G2 315mm 4000lm 840 ADV EM SO	700 mA	A++
	1,050 mA	A++

2. Thermal details

2.1 tp point, ambient temperature and life-time

The temperature at tp reference point is crucial for the light output and life-time of a LED product.

For STARK CLE a tp temperature of 65 °C has to be complied in order to achieve an optimum between light output and life-time.

Compliance with the maximum permissible reference temperature at the tc point must be checked under operating conditions in a thermally stable state. The maximum value must be determined under worst-case conditions for the relevant application.

The tc and tp temperature of LED modules from Tridonic are measured at the same reference point.

2.2 Storage and humidity

Storage temperature	-30 ... +80 °C
---------------------	----------------

Operation only in non condensing environment.

Humidity during processing of the module should be between 0 to 70 %.

2.3 Thermal design and heat sink

The rated life of LED products depends to a large extent on the temperature. If the permissible temperature limits are exceeded, the life of the STARK CLE will be greatly reduced or the STARK CLE may be destroyed.

3. Installation / wiring

3.1 Electrical supply/choice of LED Driver

STARK CLE from Tridonic are not protected against overvoltages, overcurrents, overloads or short-circuit currents. Safe and reliable operation can only be guaranteed in conjunction with a LED Driver which complies with the relevant standards. The use of TALEX converter from Tridonic in combination with STARK CLE guarantees the necessary protection for safe and reliable operation.

If a LED Driver other than from Tridonic is used, it must provide the following protection:

- Short-circuit protection
- Overload protection
- Overtemperature protection



STARK CLE must be supplied by a constant current LED Driver. Operation with a constant voltage LED Driver will lead to an irreversible damage of the module.

Wrong polarity can damage the STARK CLE.

With parallel wiring tolerance-related differences in output are possible (thermal stress of the module) and can cause differences in brightness. If one module fails, the remaining modules may be overloaded.

STARK CLE can be operated either from SELV LED Drivers or from LED Drivers with LV output voltage.



STARK CLE are basic isolated up to 300 V against ground and can be mounted directly on earthed metal parts of the luminaire. If the max. output voltage of the LED Driver (also against earth) is above 300 V, an additional isolation between LED module and heat sink is required (for example by isolated thermal pads) or by a suitable luminaire construction.

At voltages > 60 V an additional protection against direct touch (test finger) to the light emitting side of the module has to be guaranteed. This is typically achieved by means of a non removable light distributor over the module.

3.2 Wiring

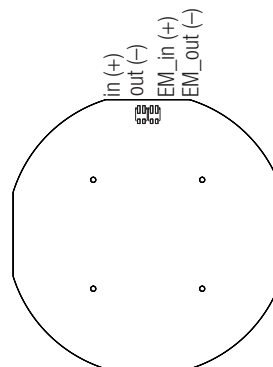

Wiring example

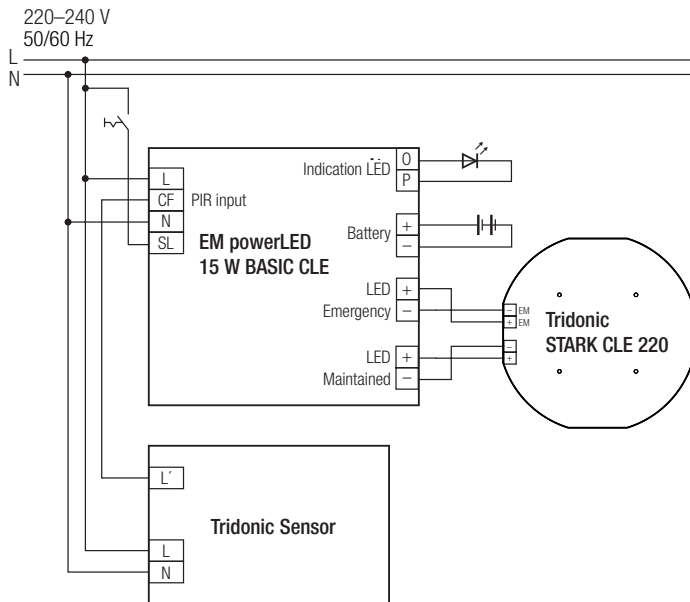
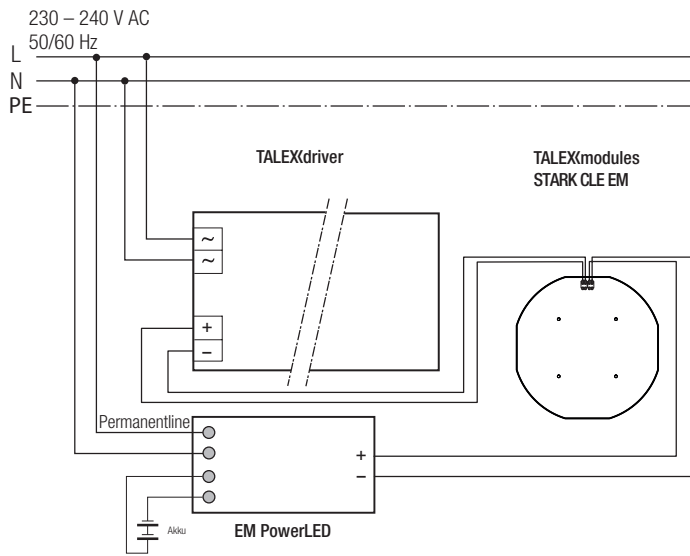

3.3 Wiring type and cross section

The wiring can be solid cable with a cross section of 0.4 to 0.75 mm². For the push-wire connection you have to strip the insulation (7-9 mm). Loosen wire through twisting and pulling.

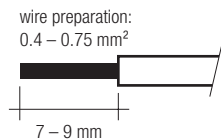

Press down the "push button" and remove the cable from front.

3.4 Mounting instruction

! None of the components of the STARK CLE (substrate, LED, electronic components etc.) may be exposed to tensile or compressive stresses.

Max. torque for fixing: 0.5 Nm.

The LED modules are mounted with 4 screws per module. In order not to damage the modules only rounded head screws and an additional plastic flat washer should be used.

! Chemical substance may harm the LED module. Chemical reactions could lead to colour shift, reduced luminous flux or a total failure of the module caused by corrosion of electrical connections.

Materials which are used in LED applications (e.g. sealings, adhesives) must not produce dissolver gas. They must not be condensation curing based, acetate curing based or contain sulfur, chlorine or phthalate. Avoid corrosive atmosphere during usage and storage.

3.5 EOS/ESD safety guidelines

! The device / module contains components that are sensitive to electrostatic discharge and may only be installed in the factory and on site if appropriate EOS/ESD protection measures have been taken. No special measures need be taken for devices/modules with enclosed casings (contact with the pc board not possible), just normal installation practice. Please note the requirements set out in the document EOS / ESD guidelines (Guideline_EOS_ESD.pdf) at: <http://www.tridonic.com/esd-protection>

4. Life-time

4.1 Life-time, lumen maintenance and failure rate

The light output of an LED Module decreases over the life-time, this is characterized with the L value.

L70 means that the LED module will give 70 % of its initial luminous flux. This value is always related to the number of operation hours and therefore defines the life-time of an LED module.

As the L value is a statistical value and the lumen maintenance may vary over the delivered LED modules.

The B value defines the amount of modules which are below the specific L value, e.g. L70B10 means 10 % of the LED modules are below 70 % of the initial luminous flux, respectively 90 % will be above 70 % of the initial value. In addition the percentage of failed modules (fatal failure) is characterized by the C value.

The F value is the combination of the B and C value. That means for F degradation and complete failures are considered, e.g. L70F10 means 10 % of the LED modules may fail or be below 70 % of the initial luminous flux.

4.2 Lumen maintenance

Life-time declarations are informative and represent no warranty claim.

CLE G2 220mm

Forward current	tp temperature	L90 / F10	L90 / F50	L80 / F10	L80 / F50	L70 / F10	L70 / F50
350 mA	65 °C	30,000 h	>50,000 h	>50,000 h	>50,000 h	>50,000 h	>50,000 h
500 mA	65 °C	24,000 h	>50,000 h	>50,000 h	>50,000 h	>50,000 h	>50,000 h

CLE G2 315mm

Forward current	tp temperature	L90 / F10	L90 / F50	L80 / F10	L80 / F50	L70 / F10	L70 / F50
700 mA	65 °C	29,000 h	>50,000 h	>50,000 h	>50,000 h	>50,000 h	>50,000 h
1,050 mA	65 °C	18,000 h	40,000 h	33,000 h	>50,000 h	>50,000 h	>50,000 h

5. Electrical values

5.1 Typ. forward voltage vs. forward current

CLE G2 220mm

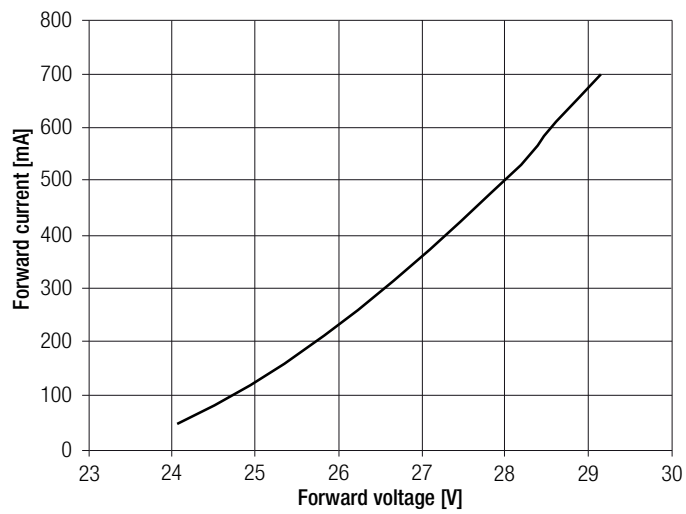

CLE G2 315mm

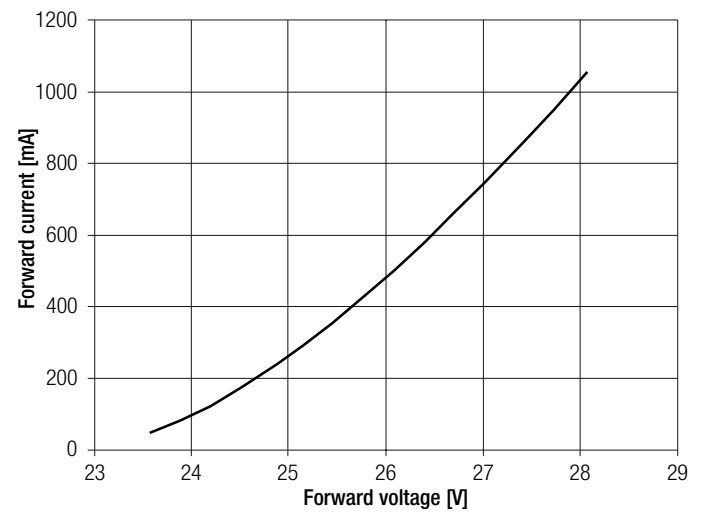

5.2 Forward voltage vs. tc temperature

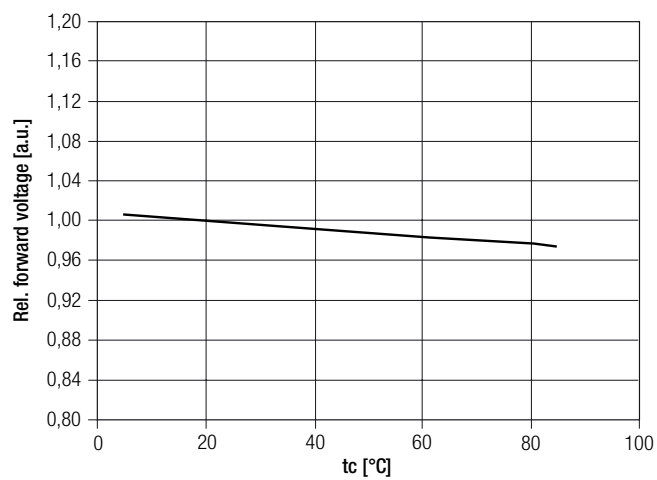

The diagrams based on statistic values. The real values can be different.

6. Photometric characteristics

6.1 Coordinates and tolerances according to CIE 1931

The specified colour coordinates are measured integral by a current impulse with typical values of module and a duration of 100 ms.

The ambient temperature of the measurement is $t_a = 25^\circ\text{C}$.

The measurement tolerance of the colour coordinates are ± 0.01 .

3,000 K

	x0	y0
Centre	0.4344	0.4032

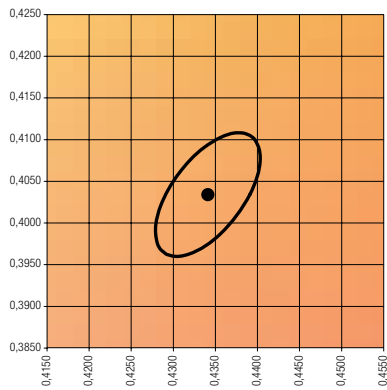

— MacAdam Ellipse: 3SDCM

4,000 K

	x0	y0
Centre	0.3825	0.3796

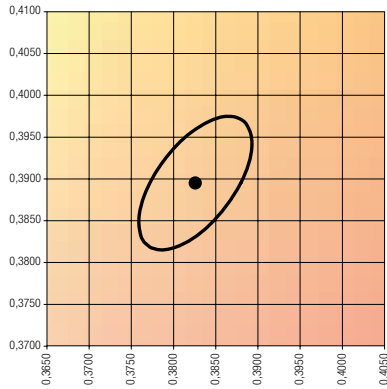

— MacAdam Ellipse: 3SDCM

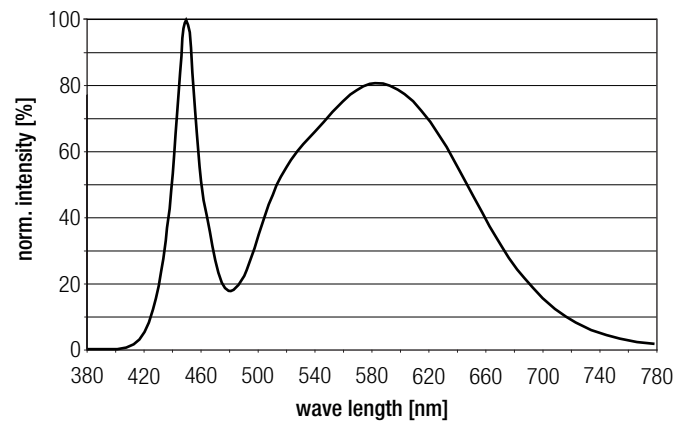
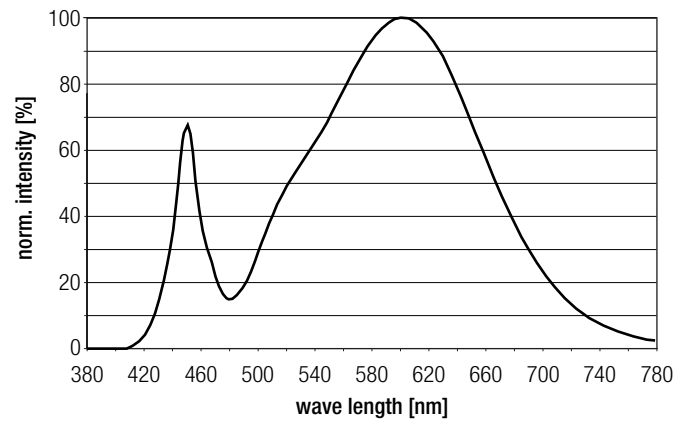

6.2 Light distribution

The optical design of the STARK CLE product line ensures optimum homogeneity for the light distribution.

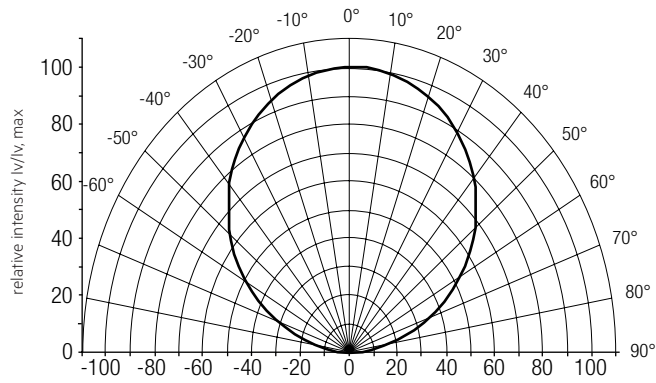

The colour temperature is measured over the complete module. The single LED light points can be outside of 3SDCM.

To ensure an ideal mixture of colours and a homogenous light distribution a suitable optic (e. g. PMMA diffuser) and a sufficient spacing between module and optic (typ. 5 cm) should be used.

3D-Data, photometric data and Design-in guide available on request or go to www.tridonic.com

6.3 Relative luminous flux vs. tc temperature

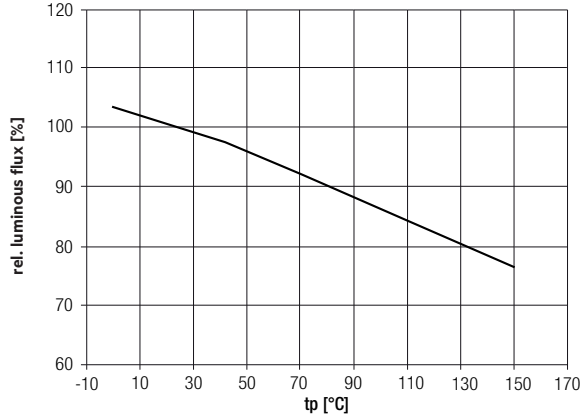

6.4 Relative luminous flux vs. operating current

CLE G2 220mm

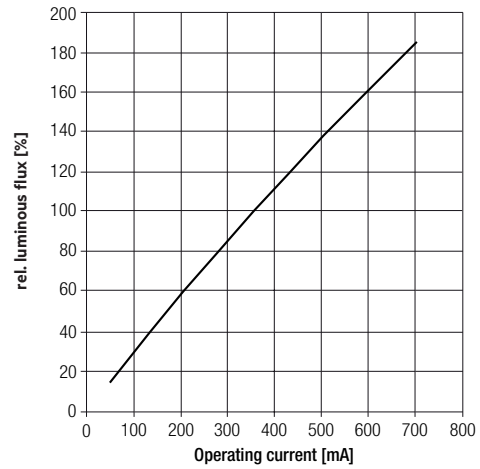

CLE G2 315mm

