

Driver LC 30W 700mA fixC C SNC

ESSENCE series

Product description

- Fixed output built-in LED Driver
- Constant current LED Driver
- Output current 700 mA
- Max. output power 30 W
- Nominal life-time up to 50,000 h
- For luminaires of protection class I and protection class II
- Temperature protection as per EN 61347-2-13 C5e
- 5-year guarantee

Properties

- Casing: polycarbonat, white
- Type of protection IP20

Functions

- Overtemperature protection
- Overload protection
- Short-circuit protection
- No-load protection



Standards, page 2

Wiring diagrams and installation examples, page 3

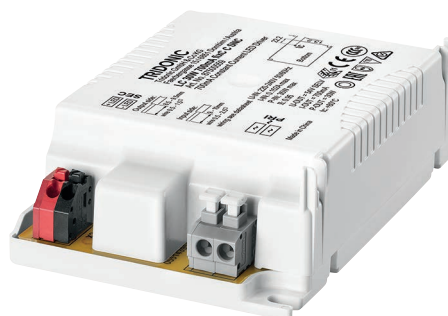

IP20 SELV 

Driver LC 30W 700mA fixC C SNC

ESSENCE series

Technical data

Rated supply voltage	220 – 240 V
AC voltage range	198 – 264 V
Input current (at 230 V, 50 Hz, full load)	0.152 A
Mains frequency	50 / 60 Hz
Typ. power consumption (at 230 V, 50 Hz, full load)	33.5 W
Max. input power	35 W
Output power range	21 – 30 W
THD (at 230 V, 50 Hz, full load)	< 20 %
Output current tolerance [®]	± 7.5 %
Typ. current ripple (at 230 V, 50 Hz, full load)	± 30 %
Turn on time (at 230 V, 50 Hz, full load)	≤ 0.5 s
Turn off time (at 230 V, 50 Hz, full load)	≤ 0.5 s
Hold on time at power failure (output)	0 s
Ambient temperature t_a	-20 ... +50 °C
Ambient temperature t_a (at life-time 50,000 h)	40 °C
Max. casing temperature t_c	80 °C
Storage temperature t_s	-40 ... +80 °C
Dimensions L x W x H	103 x 67 x 29.7 mm

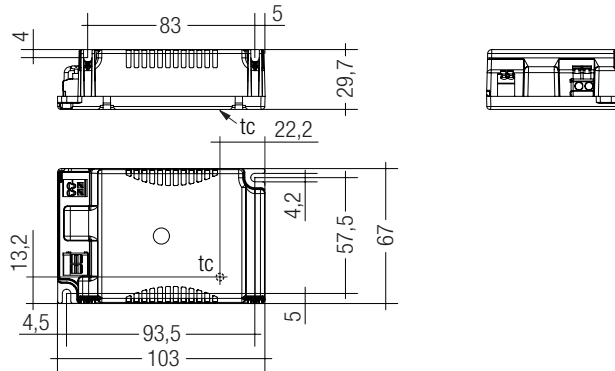

Ordering data

Type	Article number	Packaging, carton	Packaging, low volume	Packaging, high volume	Weight per pc.
LC 30W 700mA fixC C SNC	87500559	15 pc(s).	345 pc(s).	2,760 pc(s).	0.124 kg

Specific technical data

Type	Output current [®]	Power factor at full load [®]	Efficiency at full load [®]	Power factor at min. load [®]	Efficiency at min. load [®]	Min. forward voltage	Max. forward voltage	Max. output voltage	Max. output peak current at full load [®]	Max. output peak current at min. load [®]
LC 30W 700mA fixC C SNC	700 mA	0.95	91 %	0.92	90 %	30 V	43 V	54 V	980 mA	1,120 mA

[®] Test result at 230 V, 50 Hz.

[®] The trend between min. and full load is linear.

[®] Output current is mean value.

Standards

EN 55015
EN 61000-3-2
EN 61000-3-3
EN 61347-1
EN 61347-2-13
EN 61547

Overload protection

If the output voltage range is exceeded the LED Driver will protect itself and LED may flicker. After elimination of the overload, the nominal operation is restored automatically.

Overtemperature protection

The LED Driver is protected against temporary thermal overheating. If the temperature limit is exceeded, the output current is reduced to limit t_c at a certain level. The temperature protection is activated typically at 10 °C above t_c max.

Short-circuit behaviour

In case of a short circuit on the secondary side (LED) the LED Driver switches into hic-cup mode. After elimination of the short-circuit fault the LED Driver will recover automatically.

No-load operation

The LED Driver works in burst working mode to provide a constant output voltage regulation which allows the application to be able to work safely when LED string opens due to a failure.

Installation instructions

The LED module and all contact points within the wiring must be sufficiently insulated against 3 kV surge voltage. Air and creepage distance must be maintained.

Replace LED module

1. Mains off
2. Remove LED module
3. Wait for 10 seconds
4. Connect LED module again

Hot plug-in or secondary switching of LEDs is not permitted and may cause a very high current to the LEDs.

Expected life-time

Type	t_a	40 °C	50 °C	60 °C
LC 30W 700mA fixC C SNC	t_c	70 °C	80 °C	x
	Life-time	50,000h	30,000h	x

The LED Driver is designed for a life-time stated above under reference conditions and with a failure probability of less than 10 %. Life-time declarations are informative and represent no warranty claim.

Maximum loading of automatic circuit breakers

Automatic circuit breaker type	C10	C13	C16	C20	B10	B13	B16	B20	Inrush current
Installation Ø	1.5mm ²	1.5mm ²	1.5mm ²	2.5mm ²	1.5mm ²	1.5mm ²	1.5mm ²	2.5mm ²	I_{max} Time
LC 30W 700mA fixC C SNC	45	60	75	90	36	48	60	72	10 A 100 µs

Harmonic distortion in the mains supply (at 230 V / 50 Hz and full load) in %

	THD	3.	5.	7.	9.	11.
LC 30W 700mA fixC C SNC	< 20	< 11	< 2	< 2	< 2	< 1

Glow-wire test

according to EN 61347-1 with increased temperature of 850 °C passed.

Mounting of device

Max. torque for fixing: 0.5 Nm/M4

Storage conditions

Humidity: 5 % up to max. 85 %, not condensed (max. 56 days/year at 85 %)

Storage temperature: -40 °C up to max. +80 °C

The devices have to be within the specified temperature range (t_a) before they can be operated.

Wiring diagram

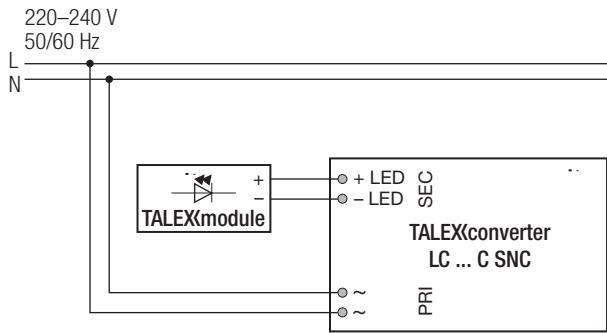

Isolation and electric strength testing of luminaires

Electronic devices can be damaged by high voltage. This has to be considered during the routine testing of the luminaires in production.

According to IEC 60598-1 Annex Q (informative only!) or ENEC 303-Annex A, each luminaire should be submitted to an isolation test with 500 V_{DC} for 1 second. This test voltage should be connected between the interconnected phase and neutral terminals and the earth terminal. The isolation resistance must be at least 2 MΩ.

As an alternative, IEC 60598-1 Annex Q describes a test of the electrical strength with 1500 V_{AC} (or 1.414 x 1500 V_{DC}). To avoid damage to the electronic devices this test must not be conducted.

Additional information

Additional technical information at www.tridonic.com → Technical Data

Guarantee conditions at www.tridonic.com → Services

Life-time declarations are informative and represent no warranty claim. No warranty if device was opened.

Wiring type and cross section

The input wiring can be stranded wires with ferrules with a cross section of 0.5 – 1.5 mm² or with solid wires with a cross section of 0.5 – 2.5 mm². Strip 9 – 10 mm of insulation from the cables to ensure perfect operation of the push-wire terminals.

The output wiring can be done with a cross section of 0.5 – 1.5 mm². Strip 8.5 – 9.5 mm of insulation from the cables to ensure perfect operation of the push-wire terminals.

Input wiring

wire preparation:
Solid: 0.5 – 2.5 mm²
Fine-stranded: 0.5 – 1.5 mm²

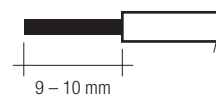

Output wiring

wire preparation:
0.5 – 1.5 mm²

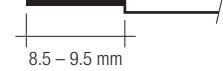

Wiring guidelines

- All connections must be kept as short as possible to ensure good EMI behaviour.
- Mains leads should be kept apart from LED Driver and other leads (ideally 5 – 10 cm distance)
- Max. length of output wires is 2 m.
- Secondary switching is not permitted.
- Incorrect wiring can damage LED modules.
- The wiring must be protected against short circuits to earth (sharp edged metal parts, metal cable clips, louver, etc.).

Release of the wiring

Press down the “push button” and remove the cable from front.

Input terminal

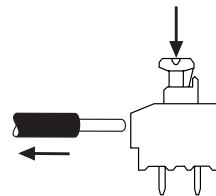

Output terminal

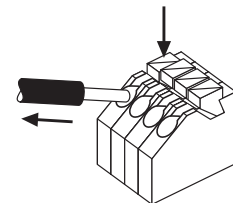

Diagrams LC 30W 700mA fixC C SNC

Efficiency vs load

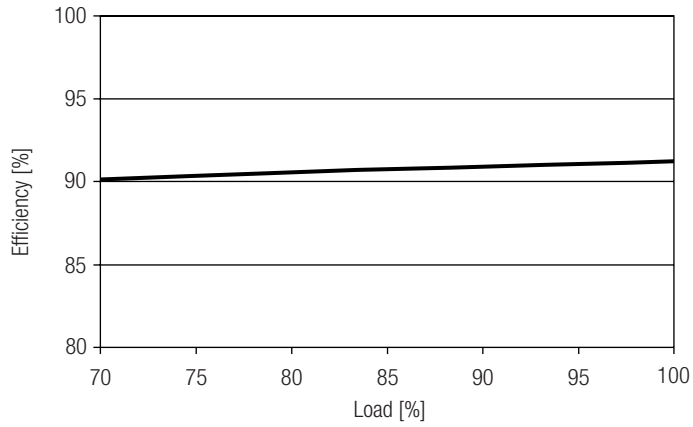

Power factor vs load

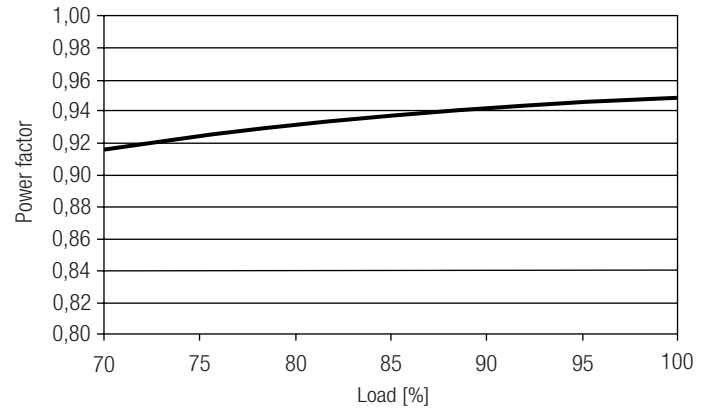

Input power vs load

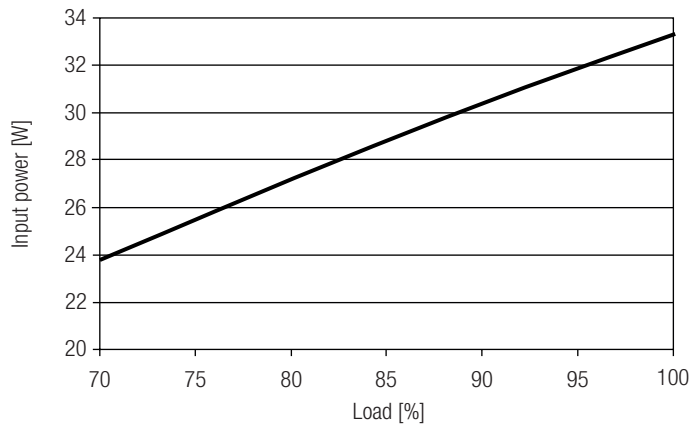

Input current vs load

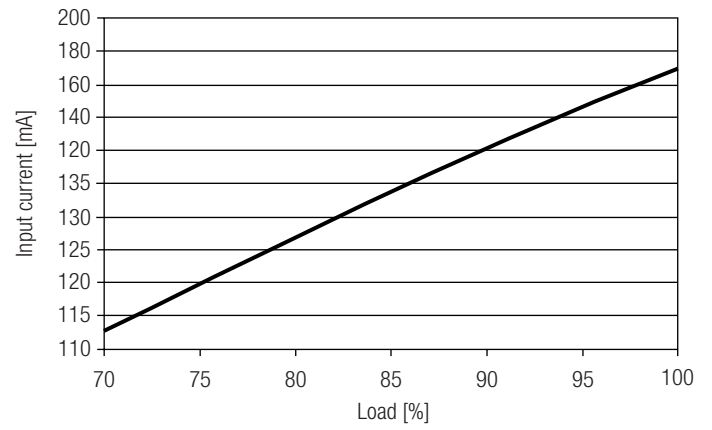

THD vs load

