



Driver LCU 48V 150W DC-STR DIM SR

Dimming

Product description

- Independent dimmable DC-String constant voltage LED Driver
- Compatible with other DC-String components
- Integrated DALI to DC powerline communication bridge (PLC)
- one4all interface (corridorFUNCTION, switchDIM, DALI, DSI)
- Max. output power 150 W
- Up to 93 % efficiency
- Nominal life-time up to 50,000 h
- For luminaires of protection class I and protection class II
- 5-year guarantee



Housing properties

- Casing: polycarbonate, white
- Type of protection IP20

Functions

- DC-String compatible
- Intelligent Temperature Guard (overtemperature protection)
- Short-circuit protection
- Overload protection



Standards, page 3



IP20 SELV 
RoHS

Driver LCU 48V 150W DC-STR DIM SR

Dimming

Technical data

Rated supply voltage	220 – 240 V
AC voltage range	198 – 264 V
DC voltage range	176 – 280 V
Mains frequency	0 / 50 / 60 Hz
Typ. current (at 230 V, 50 Hz, full load)	710 mA
Typ. current (220 V, 0 Hz, full load)	740 mA
Leakage current (at 230 V, 50 Hz, full load)	< 500 µA
Max. input power	162 W
Typ. efficiency (at 230 V / 50 Hz / full load)	92.9 %
λ (at 230 V, 50 Hz, full load)	0.99
Typ. input current in no-load operation	56.3 mA
Typ. input power in no-load operation	4.3 W
In-rush current (peak / duration)	671 A / 173 µs
THD (at 230 V, 50 Hz, full load)	< 5 %
Output voltage tolerance	-1 ... +5 %
Output LF current ripple (< 120 Hz)	± 1 %
Max. output voltage (no-load voltage)	50.5 V
Max. cable length secondary	See section 3.5
Mains surge capability (between L – N)	1 kV
Mains surge capability (between L/N – PE)	2 kV
Surge voltage at output side (against PE)	< 450 V
Ambient temperature t_a	-25 ... +50 °C
Max. casing temperature t_c	80 °C
Dimensions L x W x H	235 x 100 x 31 mm

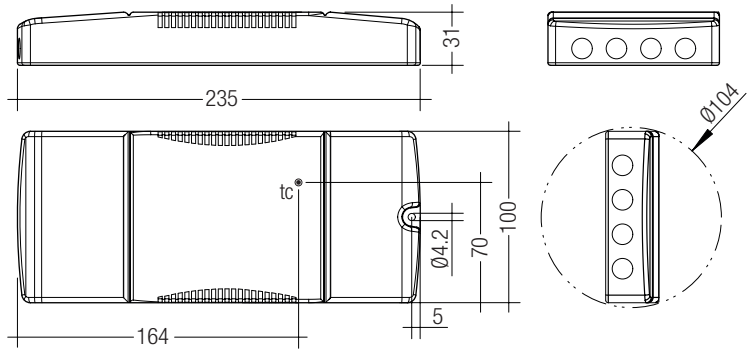

Ordering data

Type	Article number	Packaging carton	Packaging pallet	Weight per pc.
LCU 48V 150W DC-STR DIM SR	28001044	10 pc(s).	300 pc(s).	0.369 kg

We recommended using following LMI LED Drivers together with this LCU DC power supply:

Type	Article number	Packaging box	Packaging carton (contains 10 boxes)	Packaging pallet	Weight per pc.
LMI G2 48V 350-700mA 3-20V DIM slim	28000731	5 pc(s).	50 pc(s).	3,000 pc(s).	0.013 kg
LMI G2 48V 700-1050mA 3-20V DIM slim	28001583	5 pc(s).	50 pc(s).	3,000 pc(s).	0.016 kg
LMI G2 48V 350-700mA 20-42V DIM regular	28001584	5 pc(s).	50 pc(s).	3,000 pc(s).	0.012 kg
LMI G2 48V 350-700mA 20-42V DIM slim	28001585	5 pc(s).	50 pc(s).	3,000 pc(s).	0.013 kg

1. Standards

EN 55015
EN 61000-3-2
EN 61000-3-3
EN 61347-1
EN 61347-2-13
EN 62384
EN 61547
EN 62386-101 (according to DALI standard V2)

2. Thermal details and life-time

2.1 Expected life-time

Expected life-time					
Type	ta	40 °C	50 °C	55 °C	Load
LCU 48V 150W DC-STR DIM SR	Life-time	70 °C	75 °C	80 °C	100 %
		95,000 h	70,000 h	55,000 h	100 %
		180,000 h	140,000 h	100,000 h	75 %
		300,000 h	230,000 h	170,000 h	50 %
		450,000 h	340,000 h	250,000 h	25 %

The LED control gear is designed for a life-time stated above under reference conditions and with a failure probability of less than 10 %.

The relation of tc to ta temperature depends also on the luminaire design.

If the measured tc temperature is approx. 5 K below tc max., ta temperature should be checked and eventually critical components (e.g. ELCAP) measured. Detailed information on request.

3. Installation / wiring

3.1 Circuit diagram

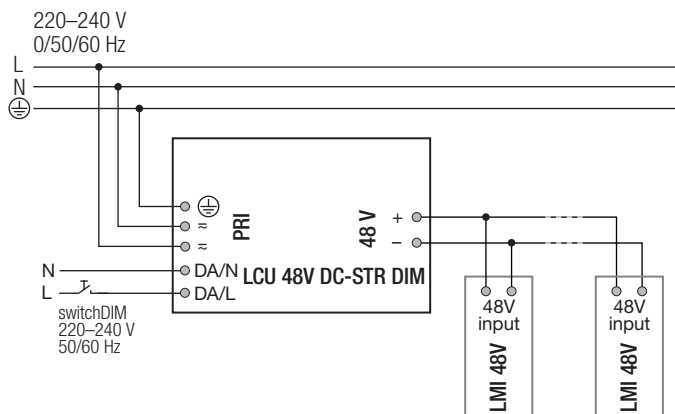
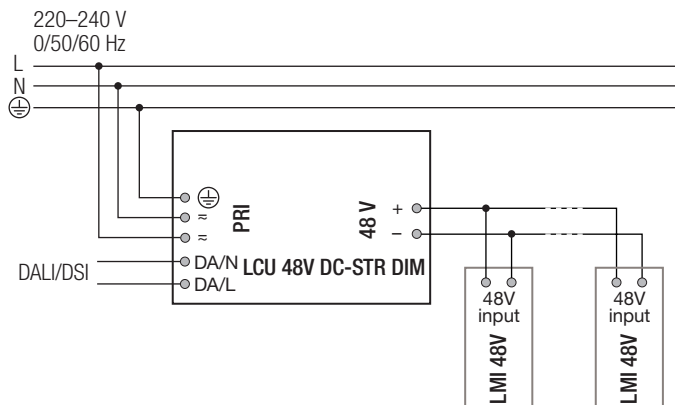

3.2 Mains supply wiring

Stranded wire or solid wire up to 2.5 mm² may be used for wiring. Strip 10–11 mm of insulation from the cables to ensure perfect operation of the push terminals.

Use one wire for each terminal connector.
Use each strain relief channel for one cable only.

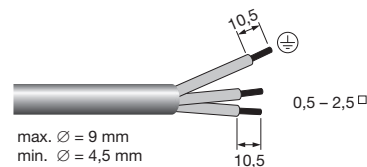

3.3 Output wiring (48 V bus)

The output wiring can be done with a cross section of 0.2 – 2.5 mm². Strip 9 – 10 mm of insulation from the cables to ensure perfect operation of the push-wire terminals.

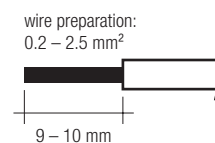

Use one wire for each terminal connector only.
Use each strain relief channel for one cable only.

3.4 Loose wiring

Input terminal

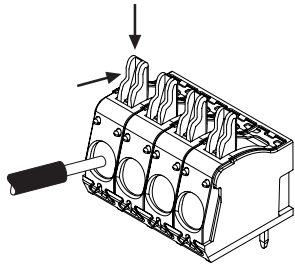

Output terminal

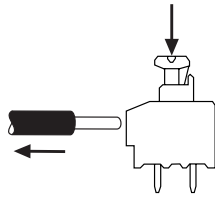

3.5 Wiring guidelines

- The 48 V cables should be run separately from the mains connections and mains cables to ensure good EMC conditions.
- The 48 V DC output wiring should be kept as short as possible to ensure good EMC. The max. secondary cable length is 30 m (60 m circuit) till beginning of a grounded metal track light. If track light is not grounded or made of plastic, cable length including track light is 30 m. Inside the track light cable length is limited by voltage drop that last LMI 48V in the track light is still supplied with minimum 46 V.
- Secondary switching is not permitted.

3.6 Hot plug-in

Hot plug-in is not supported for one DC/DC-LED Driver.

3.7 Function of the earth terminal ⊕

The device has to be earthed to fulfill EMI requirements.

4. Electrical values

4.1 Efficiency vs. load

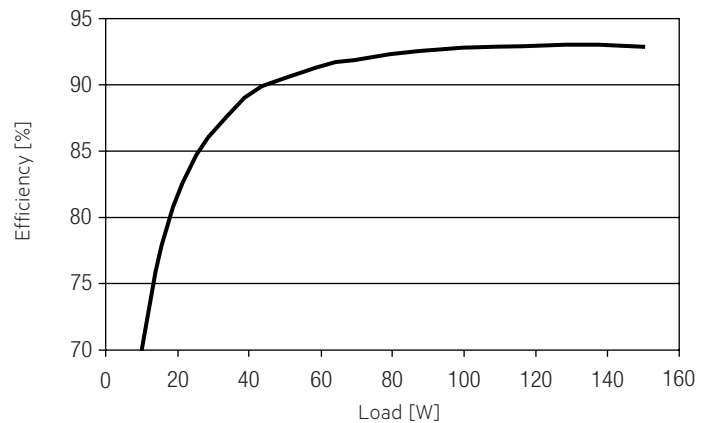

4.2 Power factor vs. Load

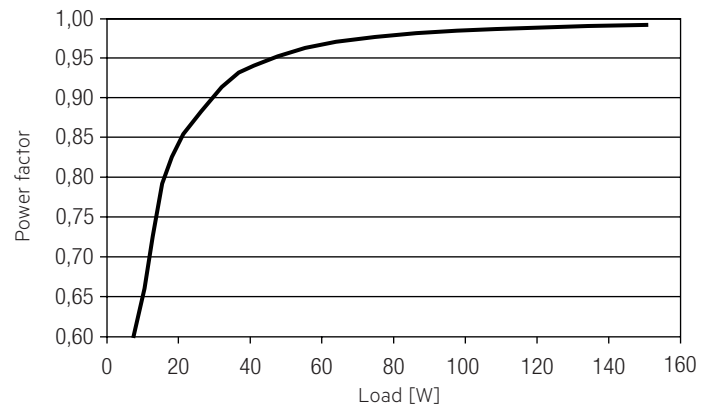

4.3 Input power vs. Load

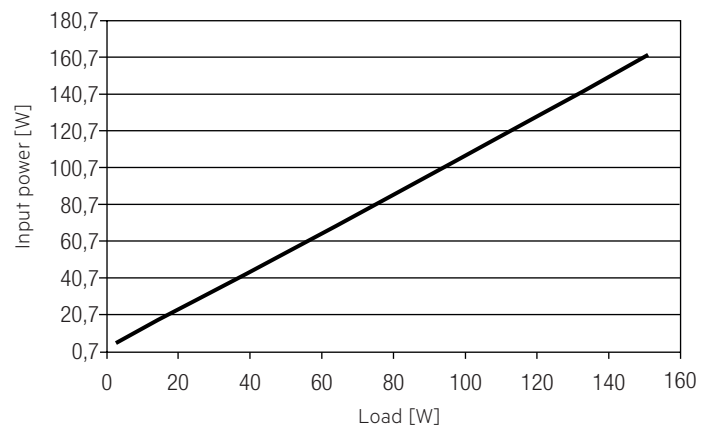

4.4 Input current vs. Load

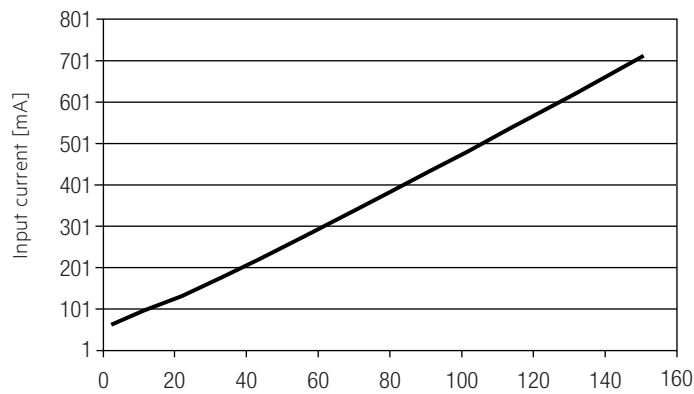

4.5 THD vs. Load

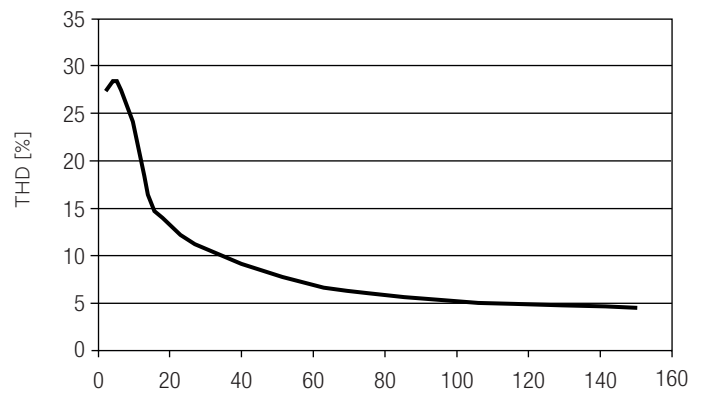

4.6 Maximum loading of automatic circuit breakers

Automatic circuit breaker type	C10	C13	C16	C20	B10	B13	B16	B20	Inrush current	
Installation Ø	1.5 mm ²	1.5 mm ²	2.5 mm ²	2.5 mm ²	1.5 mm ²	1.5 mm ²	2.5 mm ²	2.5 mm ²	I_{max}	time
LCU 48V 150W DC-STR DIM SR	8	10	13	16	5	6	8	10	59 A	220 µs

Calculation uses typical values from ABB series S200 as a reference.
Actual values may differ due to used circuit breaker types and installation environment.

4.7 Harmonic distortion in the mains supply (at 230 V / 50 Hz and full load) in %

	THD	3.	5.	7.	9.	11.
LCU 48V 150W DC-STR DIM SR	5	5	1	1	1	1

4.8 Dimming

Dimming range 70 mA to 100 % of nominal current
Digital control with:
Programmable parameter:
Minimum dimming level
Maximum dimming level
Default minimum = depending on nominal current level
Default maximum = 100 %

Dimming curve is adapted to the eye sensitiveness.
Dimming is realized by amplitude dimming.

4.9 Dimming characteristics

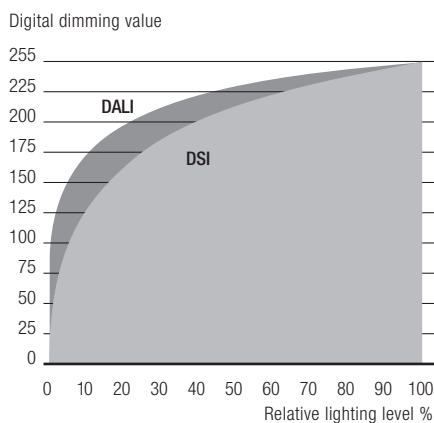

Dimming characteristics as seen by the human eye

5. Interfaces / communication

5.1 Control input (DA/N, DA/L)

Digital DALI signal or switchDIM can be wired on the same terminals (DA/N and DA/L).

The control input is non-polar for digital control signals (DALI, DSI). The control signal is not SELV. Control cable has to be installed in accordance to the requirements of low voltage installations.
Different functions depending on each module.

5.2 switchDIM

Integrated switchDIM function allows a direct connection of a pushbutton for dimming and switching.
Brief push (< 0.6 s) switches LED control gear ON and OFF. The dimm level is saved at power-down and restored at power-up.
When the pushbutton is held, LED modules are dimmed. After repush the LED modules are dimmed in the opposite direction.
In installations with LED control gears with different dimming levels or opposite dimming directions (e.g. after a system extension), all LED control gears can be synchronized to 50 % dimming level by a 10 s push.
Use of pushbutton with indicator lamp is not permitted.

5.3 PowerLineCommunication (PLC)

The communication between the LED control gear and the DC/DC-LED Driver is done over power line. The DALI signal will be modulated by the LED control gear and will be sent over the 48 V DC signal to the DC/DC-LED Driver.

5.4 DC operation

The DC power supply is designed for operation on DC voltage and pulsed DC voltage.
Behaviour in DC operation mode is the same as in AC operating mode.

6. Functions

6.1 Short-circuit behaviour

In case of a short-circuit at the output the output is switched off. After restart of the DC power supply the output will be activated again. The restart can be done via mains reset.

6.2 No-load operation

The DC power supply will not be damaged in no-load operation.

6.3 Overload protection

If the output power range is exceeded by more than 10 % the DC power supply gives a blinking signal to the DC/DC-LED Driver. The DC power supply will blink 5 times, after 30 s break, it checks again, if:

- there is no overload, then the device will go in normal operation.
- there is still overload, the device will blink again 5 times.

6.4 Overtemperature protection

The DC power supply will blink 3 times, after 30 s break, it checks again, if:

- there is no overtemperature, then the device will go in normal operation.
- there is still overtemperature, then the device will blink again 3 times.

6.5 corridorFUNCTION

Is set in the DC/DC-LED Driver.

6.6 Light level in DC operation

Is set in the DC/DC-LED Driver.

6.7 Software / programming

With appropriate software and a interface different functions can be activated and various parameters can be configured in the LED control gear. To do so, a DALI-USB and the software (masterCONFIGURATOR) are required.

6.8 masterCONFIGURATOR

From version 2.8:
For programming functions (power-up fading, corridorFUNCTION) and device settings (fade time, ePowerOnLevel, DC level, etc.).
For further information see masterCONFIGURATOR manual.

7. Miscellaneous

7.1 Isolation and electric strength testing of luminaires

Electronic devices can be damaged by high voltage. This has to be considered during the routine testing of the luminaires in production.

According to IEC 60598-1 Annex Q (informative only!) or ENEC 303-Annex A, each luminaire should be submitted to an isolation test with 500 V_{DC} for 1 second. This test voltage should be connected between the interconnected phase and neutral terminals and the earth terminal. The isolation resistance must be at least 2 MΩ.

As an alternative, IEC 60598-1 Annex Q describes a test of the electrical strength with 1500 V_{AC} (or 1.414 x 1500 V_{DC}). To avoid damage to the electronic devices this test must not be conducted.

7.2 Conditions of use and storage

Environmental conditions: 5% up to max. 85%,
not condensed
(max. 56 days/year at 85%)

Storage temperature: -40 °C up to max. +80 °C

The devices have to be acclimatised to the specified temperature range (ta) before they can be operated.

7.3 Additional information

Additional technical information at www.tridonic.com → Technical Data

Guarantee conditions at www.tridonic.com → Services

Life-time declarations are informative and represent no warranty claim. No warranty if device was opened.