



**Module STARK LLE-G3-24-140-650, LLE-G3-24-280-1250,
LLE-G3-24-560-2400 CLASSIC**

Modules LLE ADVANCED

Product description

- Ideal for linear and panel lights
- Luminous flux range 640 up to 3,390 lm
- LED system solution with outstanding system efficacy up to 141 lm/W, consisting of linear LED modules and dimmable LED Driver LCA 50W 100–400mA Ip PRE
- Efficacy of the module up to 165 lm/W
- High colour rendering index CRI > 80
- Small colour tolerance MacAdam 3[®]
- Small luminous flux tolerances
- Colour temperatures 3,000 K, 4,000 K and 5,000 K
- Perfectly uniform light, even if several LED modules are used together in a line
- Push terminals for quick and simple wiring of LED module to LED module
- Simple installation (e.g. screws)
- Long life-time: 50,000 hours
- 5-year guarantee



Standards, page 7

Colour temperatures and tolerances, page 10



Module STARK LLE-G3-24-140-650, LLE-G3-24-280-1250, LLE-G3-24-560-2400 CLASSIC

Modules LLE ADVANCED

Technical data

Beam characteristic	120°
Ambient temperature range	-40 ... +45 °C
tp rated	65 °C
tc	85 °C
Max. DC forward current	400 mA
Max. permissible LF current ripple	440 mA
Max. permissible peak current	1,000 mA / max. 10 µs
Max. permissible output voltage of LED Driver®	250 V
Insulation test voltage	1.5 kV
ESD classification	severity level 4
Risk group (EN 62471:2008)	0
Type of protection	IP00

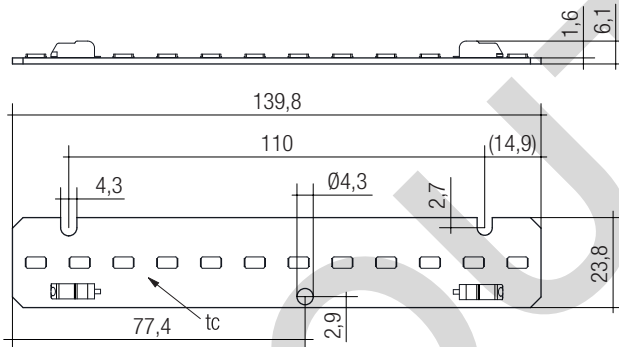

LLE-G3-24-140

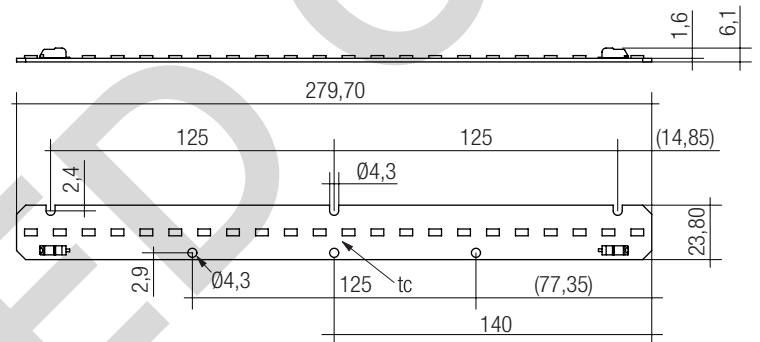

LLE-G3-24-280

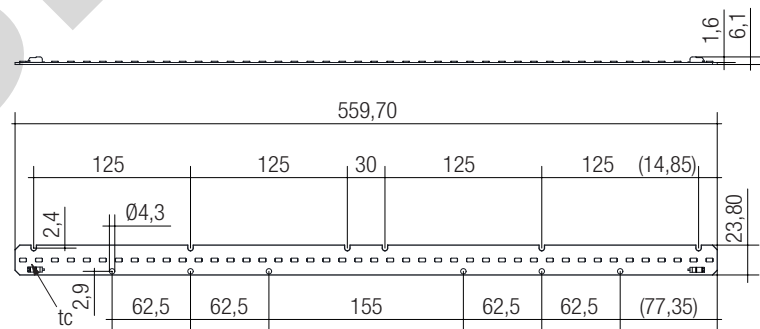

LLE-G3-24-560

Ordering data

Type	Article number	Colour temperature	Packaging carton	Weight per pc.
STARK-LLE-G3-24-140-650-830-CLA	28000391	3,000 K	480 pc(s).	0.011 kg
STARK-LLE-G3-24-140-650-840-CLA	28000392	4,000 K	480 pc(s).	0.012 kg
STARK-LLE-G3-24-280-1250-830-CLA	28000395	3,000 K	300 pc(s).	0.023 kg
STARK-LLE-G3-24-280-1250-840-CLA	28000396	4,000 K	300 pc(s).	0.023 kg
STARK-LLE-G3-24-280-1250-850-CLA	28000397	5,000 K	300 pc(s).	0.023 kg
STARK-LLE-G3-24-560-2400-830-CLA	28000400	3,000 K	240 pc(s).	0.046 kg
STARK-LLE-G3-24-560-2400-840-CLA	28000401	4,000 K	240 pc(s).	0.046 kg

Specific technical data

Type ^①	Photo-metric code	Typ. luminous flux at tp = 25 °C ^②	Typ. luminous flux at tp = 65 °C ^③	Typ. forward current	Min. forward voltage at tp = 65 °C	Max. forward voltage at tp = 25 °C	Typ. power consumption at tp = 65 °C ^④	Efficacy of the module at tp = 25 °C	Efficacy of the module at tp = 65 °C	Efficacy of the system at tp = 65 °C	Colour rendering index CRI
Operating mode HE at 250 mA											
STARK-LLE-G3-24-140-650-830	830/359	670 lm	640 lm	250 mA	15.3 V	18.9 V	4.3 W	153 lm/W	149 lm/W	131 lm/W	> 80
STARK-LLE-G3-24-140-650-840	840/359	690 lm	660 lm	250 mA	15.3 V	18.9 V	4.3 W	159 lm/W	153 lm/W	135 lm/W	> 80
STARK-LLE-G3-24-280-1250-830	830/359	1,230 lm	1,160 lm	250 mA	28.2 V	34.5 V	7.8 W	153 lm/W	149 lm/W	131 lm/W	> 80
STARK-LLE-G3-24-280-1250-840	840/359	1,270 lm	1,210 lm	250 mA	28.2 V	34.5 V	7.8 W	159 lm/W	153 lm/W	135 lm/W	> 80
STARK-LLE-G3-24-280-1250-850	850/359	1,320 lm	1,260 lm	250 mA	28.2 V	34.5 V	7.8 W	165 lm/W	161 lm/W	141 lm/W	> 80
STARK-LLE-G3-24-560-2400-830	830/359	2,460 lm	2,340 lm	250 mA	57.4 V	69.0 V	15.7 W	153 lm/W	149 lm/W	131 lm/W	> 80
STARK-LLE-G3-24-560-2400-840	840/359	2,540 lm	2,410 lm	250 mA	57.4 V	69.0 V	15.7 W	159 lm/W	153 lm/W	135 lm/W	> 80
Operating mode HO at 300 mA											
STARK-LLE-G3-24-140-650-830	830/359	780 lm	740 lm	300 mA	15.6 V	19.3 V	5.2 W	147 lm/W	142 lm/W	125 lm/W	> 80
STARK-LLE-G3-24-140-650-840	840/359	800 lm	760 lm	300 mA	15.6 V	19.3 V	5.2 W	151 lm/W	146 lm/W	129 lm/W	> 80
STARK-LLE-G3-24-280-1250-830	830/359	1,440 lm	1,360 lm	300 mA	28.8 V	35.2 V	9.6 W	147 lm/W	142 lm/W	125 lm/W	> 80
STARK-LLE-G3-24-280-1250-840	840/359	1,480 lm	1,400 lm	300 mA	28.8 V	35.2 V	9.6 W	151 lm/W	146 lm/W	129 lm/W	> 80
STARK-LLE-G3-24-280-1250-850	850/359	1,550 lm	1,460 lm	300 mA	28.8 V	35.2 V	9.6 W	158 lm/W	152 lm/W	134 lm/W	> 80
STARK-LLE-G3-24-560-2400-830	830/359	2,880 lm	2,720 lm	300 mA	58.7 V	70.3 V	19.3 W	147 lm/W	142 lm/W	125 lm/W	> 80
STARK-LLE-G3-24-560-2400-840	840/359	2,980 lm	2,810 lm	300 mA	58.7 V	70.3 V	19.3 W	151 lm/W	146 lm/W	129 lm/W	> 80
Operating mode HO at 350 mA											
STARK-LLE-G3-24-140-650-830	830/359	900 lm	840 lm	350 mA	16.0 V	19.6 V	6.2 W	141 lm/W	135 lm/W	119 lm/W	> 80
STARK-LLE-G3-24-140-650-840	840/359	930 lm	870 lm	350 mA	16.0 V	19.6 V	6.2 W	145 lm/W	140 lm/W	123 lm/W	> 80
STARK-LLE-G3-24-280-1250-830	830/359	1,640 lm	1,550 lm	350 mA	29.4 V	35.8 V	11.4 W	141 lm/W	135 lm/W	119 lm/W	> 80
STARK-LLE-G3-24-280-1250-840	840/359	1,690 lm	1,600 lm	350 mA	29.4 V	35.8 V	11.4 W	145 lm/W	140 lm/W	123 lm/W	> 80
STARK-LLE-G3-24-280-1250-850	850/359	1,760 lm	1,660 lm	350 mA	29.4 V	35.8 V	11.4 W	151 lm/W	145 lm/W	128 lm/W	> 80
STARK-LLE-G3-24-560-2400-830	830/359	3,290 lm	3,090 lm	350 mA	59.9 V	71.5 V	22.8 W	141 lm/W	135 lm/W	119 lm/W	> 80
STARK-LLE-G3-24-560-2400-840	840/359	3,390 lm	3,180 lm	350 mA	59.9 V	71.5 V	22.8 W	145 lm/W	140 lm/W	123 lm/W	> 80

^① Tolerance range for optical and electrical data: ±10 %.

^② If mounted with M4 screws and plastic washers.

^③ Integral measurement over the complete module.

^④ HE ... high efficiency, HO ... high output.

Product description

- LINEAR COVER for LLE 24
- Protection against direct touch for non-SELV applications
- Fast snap on mounting on to LLE 24 with clips or plastic washers
- High transmission: transparent 94 %, semi-transparent 87 %, diffuse 76 %
- Made of PMMA
- Tolerances: ± 1 mm for 597 mm length (ends finished),
+ 20 mm for 1,200 / 1,500 / 1,600 / 1,800 mm length (ends raw)

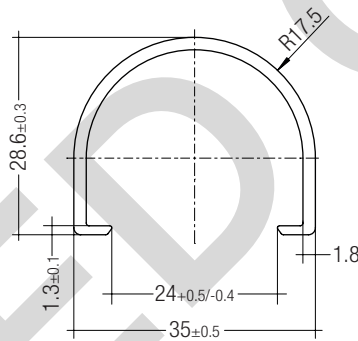
**Ordering data**

Type	Article number	Colour	Length	Packaging carton	Weight per pc.
LINEAR COVER SY Transparent 1600mm	28000338	Transparent	1,600 mm	12 pc(s).	0.272 kg
LINEAR COVER SY Frosted 1800mm	28000437	Semi-transparent	1,800 mm	12 pc(s).	0.308 kg
LINEAR COVER SY Frosted 1600mm	28000339	Semi-transparent	1,600 mm	12 pc(s).	0.272 kg
LINEAR COVER SY Frosted 1500mm	28000435	Semi-transparent	1,500 mm	12 pc(s).	0.244 kg
LINEAR COVER SY Frosted 1200mm	28000422	Semi-transparent	1,200 mm	12 pc(s).	0.205 kg
LINEAR COVER SY Frosted 597mm	28000340	Semi-transparent	597 mm	12 pc(s).	0.102 kg
LINEAR COVER SY Diffuse 1800mm	28000438	Diffuse	1,800 mm	12 pc(s).	0.308 kg
LINEAR COVER SY Diffuse 1600mm	28000341	Diffuse	1,600 mm	12 pc(s).	0.272 kg
LINEAR COVER SY Diffuse 1500mm	28000436	Diffuse	1,500 mm	12 pc(s).	0.257 kg
LINEAR COVER SY Diffuse 1200mm	28000434	Diffuse	1,200 mm	12 pc(s).	0.205 kg
LINEAR COVER SY Diffuse 597mm	28000342	Diffuse	597 mm	12 pc(s).	0.102 kg

ACL ENDCAP LLE24 PUSH-FIX

Product description

- ENDCAP for LLE 24
- Fast snap on mounting (sheet thickness 0.5 – 1.0 mm), for drilling hole 4 mm
- Made of Polycarbonat

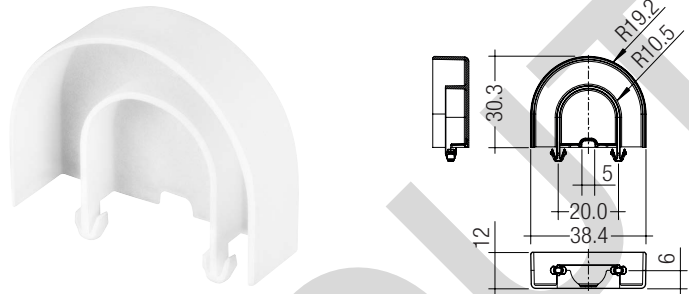

Ordering data

Type	Article number	Colour	Packaging carton	Weight per pc.
ACL ENDCAP LLE24 PUSH-FIX	28001037	White	480 pc(s).	0.003 kg

LINEAR LENS

Product description

- Linear lens for LLE 24
- Available in 60° and 90° light distribution
- Protection against direct touch for non-SELV applications
- Fast snap on mounting on to LLE 24 with clips or plastic washers
- High transmission: semi-transparent 97 %
- Linear lense made of PMMA
- Tolerances: ± 20 mm for 1,600 mm length (ends raw)

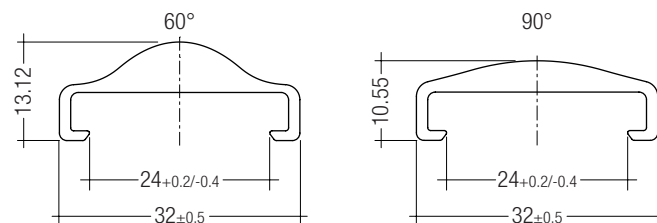

Ordering data

Type	Article number	Colour	Length	Packaging carton	Weight per pc.
ACL LINEAR LENS 24x1200mm 60°	28001428	semi-transparent	1,200 mm	21 pc(s).	0.196 kg
ACL LINEAR LENS 24x1200mm 90°	28001429	semi-transparent	1,200 mm	21 pc(s).	0.165 kg
ACL LINEAR LENS 24x1600mm 60°	28000953	semi-transparent	1,600 mm	21 pc(s).	0.261 kg
ACL LINEAR LENS 24x1600mm 90°	28000955	semi-transparent	1,600 mm	21 pc(s).	0.221 kg

CLIP 4.3mm

Product description

- Clip for fixation of LED modules with 4.3 mm holes
- Fast snap on mounting (sheet thickness 0.5 – 1.0 mm)
- For drilling hole 4 mm
- Clip made of Polycarbonat

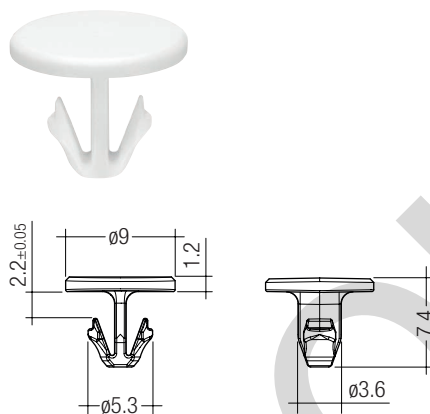

Ordering data

Type	Article number	Colour	Packaging bag ^①	Weight per pc.
ACL CLIP 4.3mm PUSH-FIX	28001036	White	500 pc(s).	0.001 kg

^① Minimum sales quantity 500 pcs.

BRIDGE LLE24/40

Product description

- Enables the fixation of 24 mm wide Tridonic LED modules to fixtures made for 40 mm wide modules
- Ideal for extruded aluminium gear trays made for 40 mm modules with pre-alignment knobs
- Clip-on for LINEAR COVER and LINEAR LENS[®]
- For LLE 24 with 280 mm module minimum 2 bridges required
- For LLE 24 with 560 mm module minimum 3 bridges required
- Fixation via M3 or M4 countersunk screw, max. tightening torque 0.5 Nm
- BRIDGE made of white polycarbonate

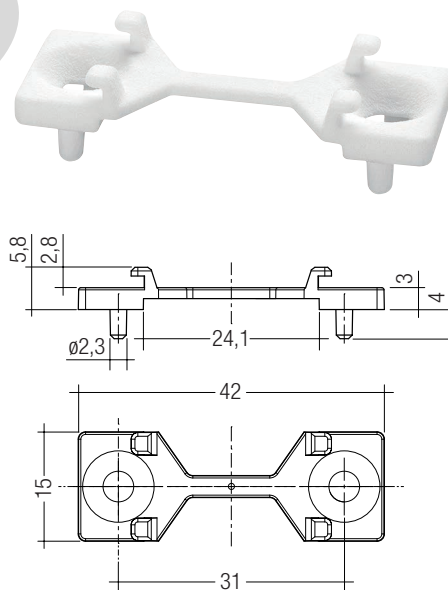

Ordering data

Type	Article number	Colour	Packaging carton ^①	Weight per pc.
ACL BRIDGE LLE24/40 SCREW-FIX	28001205	White	600 Stk.	0.001 kg

^① Minimum sales quantity 600 pcs.

^② Beam characteristics will change due to the elevated fixation (see photometric files for details).

1. Standards

EN 62031
EN 62471
EN 61347-1
EN 61547
EN 55015

1.1 Photometric code

Key for photometric code, e. g. 830 / 349

1 st digit	2 nd + 3 rd digit	4 th digit	5 th digit	6 th digit				
Code	CRI	Colour temperature in Kelvin x 100	McAdam initial	McAdam after 25% of the life-time (max.6000h)	Luminous flux after 25% of the life-time (max.6000h)			
7	70 – 79				Code	Luminous flux	7	≥ 70 %
8	80 – 89						8	≥ 80 %
9	≥90						9	≥ 90 %

1.2 Energy classification

Type	Forward current	Energy classification
LLE-G3-24-140-650-830	250 mA	A++
	300 mA	A++
	350 mA	A++
LLE-G3-24-140-650-840	250 mA	A++
	300 mA	A++
	350 mA	A++
LLE-G3-24-280-1250-830	250 mA	A++
	300 mA	A++
	350 mA	A++
LLE-G3-24-280-1250-840	250 mA	A++
	300 mA	A++
	350 mA	A++
LLE-G3-24-280-1250-850	250 mA	A++
	300 mA	A++
	350 mA	A++
LLE-G3-24-560-2400-830	250 mA	A++
	300 mA	A++
	350 mA	A++
LLE-G3-24-560-2400-840	250 mA	A++
	300 mA	A++
	350 mA	A++

2. Thermal details

2.1 tc point, ambient temperature and life-time

The temperature at tp reference point is crucial for the light output and life-time of a LED product.

For STARK LLE a tp temperature of 65 °C has to be complied in order to achieve an optimum between heat sink requirements, light output and life-time.

Compliance with the maximum permissible reference temperature at the tc point must be checked under operating conditions in a thermally stable state. The maximum value must be determined under worst-case conditions for the relevant application.

The tc and tp temperature of LED modules from Tridonic are measured at the same reference point.

2.2 Storage and humidity

Storage temperature	-40 ... +85 °C
---------------------	----------------

Operation only in non condensing environment.

Humidity during processing of the module should be between 0 to 80 %.

2.3 Thermal design and heat sink

The rated life of LED products depends to a large extent on the temperature. If the permissible temperature limits are exceeded, the life of the STARK LLE will be greatly reduced or the STARK LLE may be destroyed.

2.4 Heat sink values

STARK LLE-G3-24-650

ta	tp	Forward current	R _{th, hs-a}	Cooling area
25 °C	65 °C	250 mA	16.6 K/W	40.2 cm ²
25 °C	65 °C	300 mA	12.8 K/W	52.1 cm ²
25 °C	65 °C	350 mA	10.1 K/W	66.0 cm ²
35 °C	65 °C	250 mA	12.1 K/W	55.1 cm ²
35 °C	65 °C	300 mA	9.2 K/W	72.5 cm ²
35 °C	65 °C	350 mA	7.2 K/W	92.6 cm ²
45 °C	65 °C	250 mA	7.6 K/W	87.7 cm ²
45 °C	65 °C	300 mA	5.7 K/W	117.0 cm ²
45 °C	65 °C	350 mA	4.3 K/W	155.0 cm ²

STARK LLE-G3-24-1250

ta	tp	Forward current	R _{th, hs-a}	Cooling area
25 °C	65 °C	250 mA	8.5 K/W	78.0 cm ²
25 °C	65 °C	300 mA	7.5 K/W	88.9 cm ²
25 °C	65 °C	350 mA	4.9 K/W	136.1 cm ²
35 °C	65 °C	250 mA	6.0 K/W	111.1 cm ²
35 °C	65 °C	300 mA	4.4 K/W	151.5 cm ²
35 °C	65 °C	350 mA	3.3 K/W	202.0 cm ²
45 °C	65 °C	250 mA	3.5 K/W	190.5 cm ²
45 °C	65 °C	300 mA	2.4 K/W	277.8 cm ²
45 °C	65 °C	350 mA	1.7 K/W	392.2 cm ²

STARK LLE-G3-24-560-2400

ta	tp	Forward current	R _{th, hs-a}	Cooling area
25 °C	65 °C	250 mA	4.2 K/W	156.0 cm ²
25 °C	65 °C	300 mA	3.7 K/W	177.8 cm ²
25 °C	65 °C	350 mA	2.4 K/W	272.2 cm ²
35 °C	65 °C	250 mA	3.0 K/W	222.2 cm ²
35 °C	65 °C	300 mA	2.2 K/W	303.0 cm ²
35 °C	65 °C	350 mA	1.6 K/W	404.0 cm ²
45 °C	65 °C	250 mA	1.7 K/W	381.0 cm ²
45 °C	65 °C	300 mA	1.2 K/W	555.6 cm ²
45 °C	65 °C	350 mA	0.8 K/W	784.4 cm ²

Notes

The actual cooling surface can differ because of the material, the structural shape, outside influences and the installation situation. Depending on the heat sink a heat conducting paste or heat conducting film might be necessary to keep the specified tp temperature.

3. Installation / wiring

3.1 Electrical supply/choice of LED Driver

STARK LLE from Tridonic are not protected against overvoltages, overcurrents, overloads or short-circuit currents. Safe and reliable operation can only be guaranteed in conjunction with a LED Driver which complies with the relevant standards. The use of LED Driver from Tridonic in combination with STARK LLE guarantees the necessary protection for safe and reliable operation.

If a LED Driver other than from Tridonic is used, it must provide the following protection:

- Short-circuit protection
- Overload protection
- Overtemperature protection

 STARK LLE must be supplied by a constant current LED Driver. Operation with a constant voltage LED Driver will lead to an irreversible damage of the module.

Wrong polarity can damage the STARK LLE.

If STARK LLE are wired in parallel and a wire breaks or a complete module fails then the current passing through the other module increases. This may reduce its life considerably. In addition there can be slight differences in light output caused by tolerances.

STARK LLE can be operated either from SELV LED Drivers or from LED Drivers with LV output voltage.

 STARK LLE are basic isolated up to 250 V (if mounted with M4 screws in combination with plastic washers) against ground and can be mounted directly on earthed metal parts of the luminaire. If the max. output voltage of the LED Driver (also against earth) is above 250 V, an additional isolation between LED module and heat sink is required (for example by isolated thermal pads) or by a suitable luminaire construction.

At voltages > 60 V an additional protection against direct touch (test finger) to the light emitting side of the module has to be guaranteed. This is typically achieved by means of a non removable light distributor over the module.

3.2 Wiring



Wiring examples

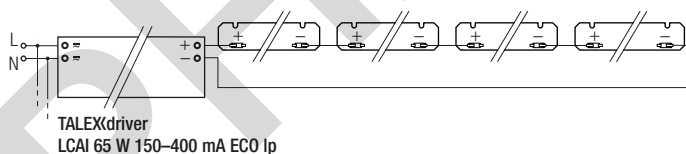

3.3 Wiring type and cross section

The wiring can be in stranded wires with ferrules or solid with a cross section of 0.2 to 0.75 mm².

For the push-wire connection you have to strip the insulation (8–9 mm).

wire preparation:
0.2 – 0.75 mm²

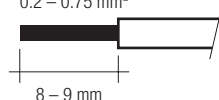

To remove the wires use a suitable tool (e.g. Microcon release pin) or through twist and pull.

3.4 Mounting instruction

 None of the components of the STARK LLE (substrate, LED, electronic components etc.) may be exposed to tensile or compressive stresses.

Max. torque for fixing: 0.5 Nm.

The LED modules are mounted onto a heat sink with min. 3 screws per module. In order not to damage the modules only rounded head screws and an additional plastic flat washer should be used.

 Chemical substance may harm the LED module. Chemical reactions could lead to colour shift, reduced luminous flux or a total failure of the module caused by corrosion of electrical connections.

Materials which are used in LED applications (e.g. sealings, adhesives) must not produce dissolver gas. They must not be condensate curing based, acetate curing based or contain sulfur, chlorine or phthalate. Avoid corrosive atmosphere during usage and storage.

3.5 EOS/ESD safety guidelines

 The device / module contains components that are sensitive to electrostatic discharge and may only be installed in the factory and on site if appropriate EOS/ESD protection measures have been taken. No special measures need be taken for devices/modules with enclosed casings (contact with the pc board not possible), just normal installation practice. Please note the requirements set out in the document EOS / ESD guidelines (Guideline_EOS_ESD.pdf) at: <http://www.tridonic.com/esd-protection>

4. Life-time

4.1 Life-time, lumen maintenance and failure rate

The light output of an LED Module decreases over the life-time, this is characterized with the L value.

L70 means that the LED module will give 70 % of its initial luminous flux. This value is always related to the number of operation hours and therefore defines the life-time of an LED module.

As the L value is a statistical value and the lumen maintenance may vary over the delivered LED modules.

The B value defines the amount of modules which are below the specific L value, e.g. L70B10 means 10 % of the LED modules are below 70 % of the initial luminous flux, respectively 90 % will be above 70 % of the initial value. In addition the percentage of failed modules (fatal failure) is characterized by the C value.

The F value is the combination of the B and C value. That means for F degradation and complete failures are considered, e.g. L70F10 means 10 % of the LED modules may fail or be below 70 % of the initial luminous flux.

4.2 Lumen maintenance for STARK LLE-G3-24

Forward current	tp temperature	L90 / F10	L90 / F50	L80 / F10	L80 / F50	L70 / F10	L70 / F50
250 mA	65 °C	23,000 h	35,000 h	49,000 h	>60,000 h	>60,000 h	>60,000 h
300 mA	65 °C	20,000 h	30,000 h	43,000 h	>60,000 h	>60,000 h	>60,000 h
350 mA	65 °C	17,000 h	26,000 h	36,000 h	55,000 h	58,000 h	>60,000 h

5. Electrical values

5.1 Typ. forward voltage vs. forward current

LLE-G3-24-140-650

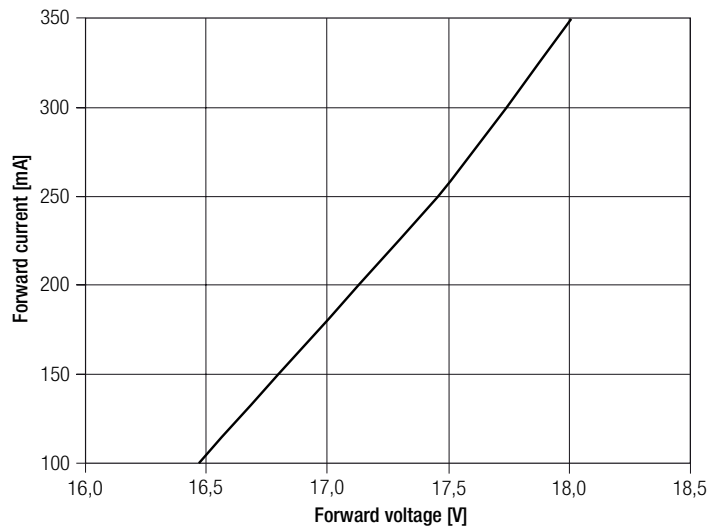

LLE-G3-24-280-1250

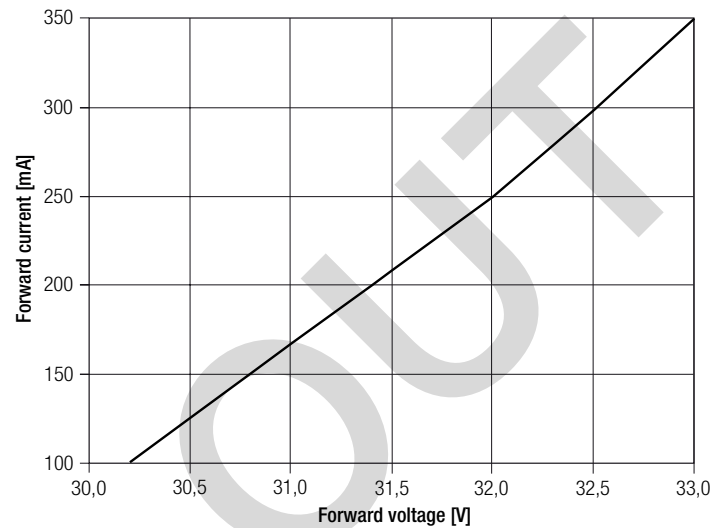

LLE-G3-24-560-2400

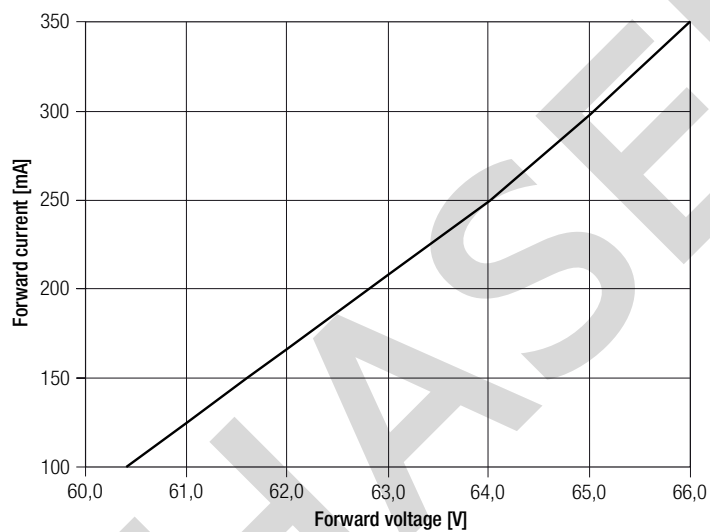

The diagrams are based on statistic values.
The real values can be different.

6. Photometric characteristics

6.1 Coordinates and tolerances according to CIE 1931

The specified colour coordinates are integral measured by current impulse of 250 mA and a duration of 100 ms.

The ambient temperature of the measurement is $t_a = 25^\circ\text{C}$.

The measurement tolerance of the colour coordinates are ± 0.01 .

3,000 K

	x0	y0
Centre	0,4344	0,4032

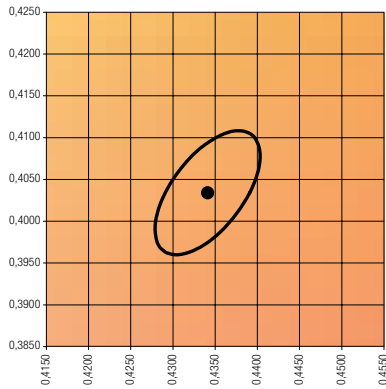

— MacAdam Ellipse: 3SDCM

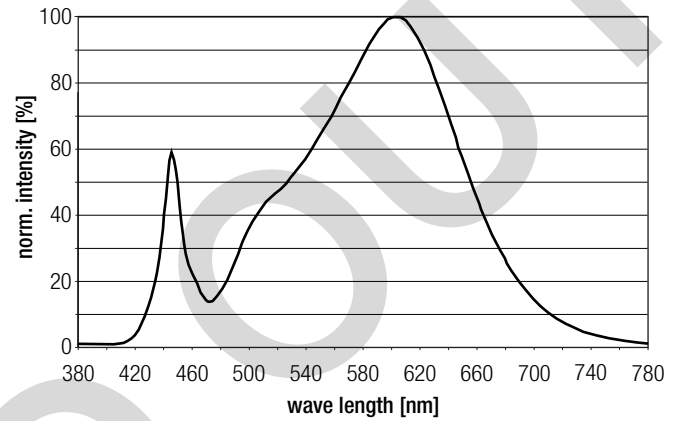

4,000 K

	x0	y0
Mittelpunkt	0,3828	0,3803

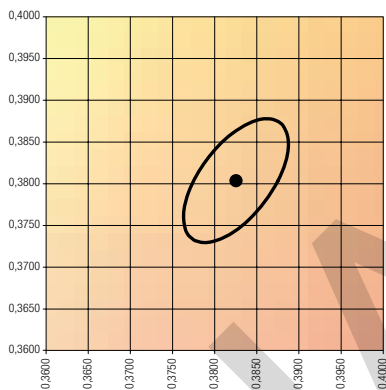

— MacAdam Ellipse: 3SDCM

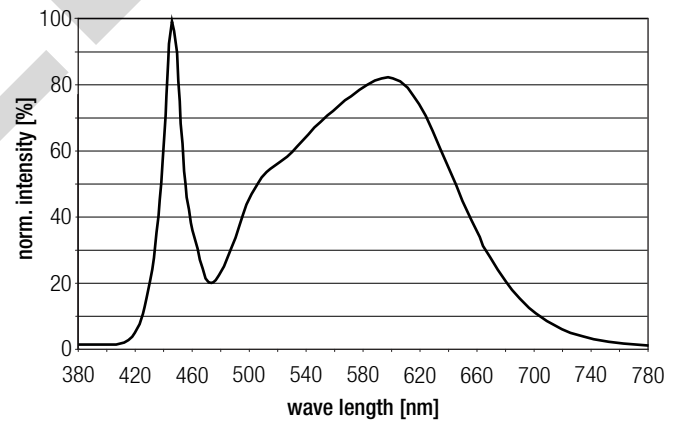

5,000 K

	x0	y0
Mittelpunkt	0,3452	0,3558

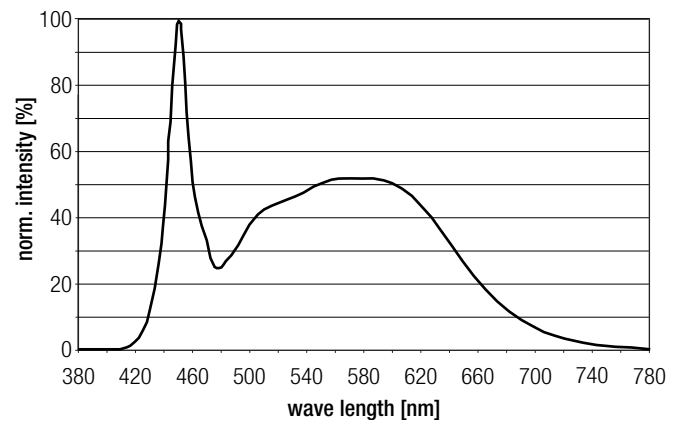
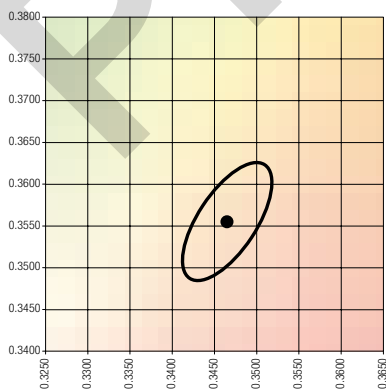

6.2 Light distribution

The optical design of the STARK LLE product line ensures optimum homogeneity for the light distribution.

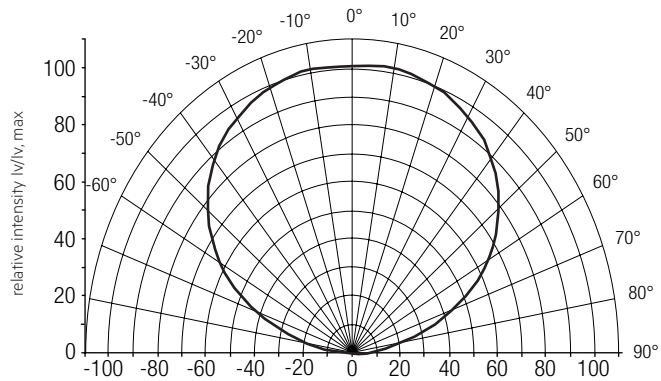

The colour temperature is measured integral over the complete module. The single LED light points can have deviations in the colour coordinates within MacAdam 7.

To ensure an ideal mixture of colours and a homogenous light distribution a suitable optic (e. g. PMMA diffuser) and a sufficient spacing between module and optic (typ. 4 cm) should be used.

For further information see Design-in Guide, 3D data and photometric data on www.tridonic.com or on request.

6.3 Relative luminous flux vs. tc temperature

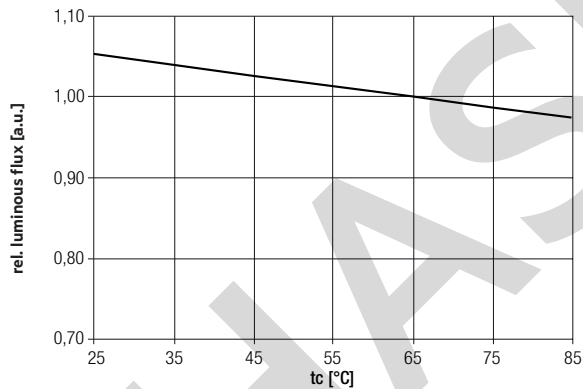

6.4 Relative luminous flux vs. operating current

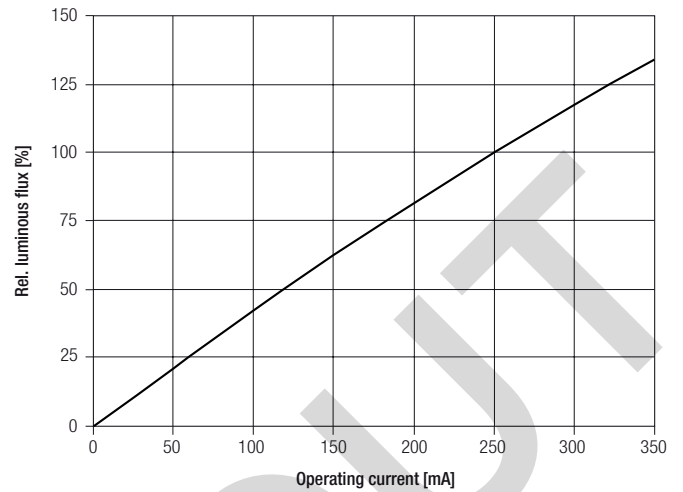

The diagrams are based on statistic values. The real values can be different.