









IP20 SELV         

RoHS

Driver LCI 55W 900mA-1750mA TOP SR

TOP series

Product description

- Independent fixed output LED Driver
- Constant current LED Driver
- Output current settable 900 – 1,750 mA
- Max. output power 55 W
- Nominal life-time up to 100,000 h
- For luminaires of protection class I and protection class II
- For luminaires with M and MM as per EN 60598, VDE 0710 and VDE 0711
- Temperature protection as per EN 61347-2-13 C5e
- 5-year guarantee

Properties

- Casing: polycarbonate, white
- Type of protection IP20
- No tools required for installation
- Through wiring possible
- Integrated terminal cover and strain relief
- 5 separate strain reliefs
- Accessory LCF 12V FAN DRIVER fits into the secondary wiring area of the LED Driver

Functions

- Intelligent Temperature Guard (overtemperature protection)
- Intelligent Temperature Management (temperature monitoring of LED module)
- Short-circuit proof
- Overload protection
- Suitable for emergency escape lighting systems acc. to EN 50172

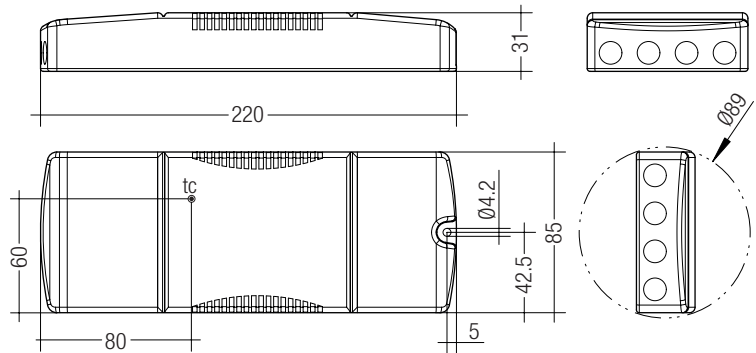

Ordering data

| Type | Article number | Packaging carton | Packaging pallet | Weight per pc. |
|-----------------------------|----------------|------------------|------------------|----------------|
| LCI 55W 900mA-1750mA TOP SR | 28000200 | 10 pc(s). | 400 pc(s). | 0.251 kg |



Standards, page 5

Technical data

| | |
|---|--------------------------------|
| Rated supply voltage | 220 – 240 V |
| AC voltage range | 198 – 264 V |
| DC voltage range | 176 – 280 V (start ≥ 198 V DC) |
| Mains frequency | 0 / 50 / 60 Hz |
| Overvoltage protection | 320 V AC, 48 h |
| Leakage current (PE) | < 0.5 mA |
| Max. input power | 64.5 W |
| Efficiency (at 230 V, 50 Hz, full load) | 88 – 90 % |
| THD (at 230 V, 50 Hz, full load) | 10 % |
| Output current tolerance | ± 5 % |
| Output LF current ripple (< 120 Hz) | < 3 % |
| Max. peak output current | Output current + 20 % |
| Max. output voltage (no-load voltage) | 60 V |
| Time to light | < 0.5 s |
| Hold on time at power failure or switch-off | < 0.5 s |
| Switchover time (AC/DC) | < 0.5 s |
| Burst / surge peaks output side against PE | 2 kV |
| Dimensions L x W x H | 220 x 85 x 31 mm |

Specific technical data

| Type | Output current | Min. forward voltage ^① | Max. forward voltage | Max. output power | Input power (at 230 V, 50 Hz, full load) | Input current (at 230 V, 50 Hz, full load) | λ (at 230 V, 50 Hz, full load) | tc point | Ambient temperature ta | tc/ta for ≥ 50.000 h | I sel resistor value |
|------------------------------------|----------------|-----------------------------------|----------------------|-------------------|--|--|--------------------------------|----------------|------------------------|----------------------|----------------------|
| LCI 55W 900mA-1750mA TOP SR | 900 mA | 22 V | 48.0 V | 43.2 W | 48.2 W | 216 mA | 0.97 | 70 °C | -25 ... +55 °C | 70 / 55 °C | open circuit |
| | 950 mA | 22 V | 48.0 V | 45.6 W | 50.9 W | 228 mA | 0.97 | 70 °C | -25 ... +55 °C | 70 / 55 °C | 69.80 kΩ |
| | 1,000 mA | 22 V | 48.0 V | 48.0 W | 53.6 W | 239 mA | 0.98 | 70 °C | -25 ... +55 °C | 70 / 55 °C | 64.90 kΩ |
| | 1,050 mA | 22 V | 48.0 V | 50.4 W | 56.3 W | 251 mA | 0.98 | 70 °C | -25 ... +55 °C | 70 / 55 °C | 56.00 kΩ |
| | 1,100 mA | 22 V | 48.0 V | 52.8 W | 58.9 W | 262 mA | 0.98 | 65 °C | -25 ... +50 °C | 65 / 50 °C | 47.50 kΩ |
| | 1,150 mA | 22 V | 47.8 V | 55.0 W | 61.6 W | 274 mA | 0.98 | 65 °C | -25 ... +50 °C | 65 / 50 °C | 43.20 kΩ |
| | 1,200 mA | 21 V | 45.8 V | 55.0 W | 61.4 W | 273 mA | 0.98 | 65 °C | -25 ... +50 °C | 65 / 50 °C | 40.20 kΩ |
| | 1,250 mA | 20 V | 44.0 V | 55.0 W | 61.2 W | 272 mA | 0.98 | 65 °C | -25 ... +50 °C | 65 / 50 °C | 36.50 kΩ |
| | 1,300 mA | 19 V | 42.3 V | 55.0 W | 61.4 W | 273 mA | 0.98 | 65 °C | -25 ... +50 °C | 65 / 50 °C | 32.40 kΩ |
| | 1,350 mA | 18 V | 40.7 V | 55.0 W | 61.3 W | 273 mA | 0.98 | 65 °C | -25 ... +50 °C | 65 / 50 °C | 28.70 kΩ |
| | 1,400 mA | 18 V | 39.3 V | 55.0 W | 61.9 W | 275 mA | 0.98 | 65 °C | -25 ... +50 °C | 65 / 50 °C | 22.00 kΩ |
| | 1,450 mA | 17 V | 37.9 V | 55.0 W | 61.5 W | 274 mA | 0.98 | 65 °C | -25 ... +50 °C | 65 / 50 °C | 17.80 kΩ |
| | 1,500 mA | 17 V | 36.7 V | 55.0 W | 61.8 W | 275 mA | 0.98 | 65 °C | -25 ... +50 °C | 65 / 50 °C | 15.00 kΩ |
| | 1,550 mA | 16 V | 35.5 V | 55.0 W | 62.1 W | 276 mA | 0.98 | 65 °C | -25 ... +50 °C | 65 / 50 °C | 12.10 kΩ |
| | 1,600 mA | 15 V | 34.4 V | 55.0 W | 62.2 W | 277 mA | 0.98 | 65 °C | -25 ... +50 °C | 65 / 50 °C | 9.30 kΩ |
| | 1,650 mA | 15 V | 33.3 V | 55.0 W | 62.3 W | 277 mA | 0.98 | 65 °C | -25 ... +50 °C | 65 / 50 °C | 6.49 kΩ |
| | 1,700 mA | 15 V | 32.4 V | 55.0 W | 62.6 W | 278 mA | 0.98 | 65 °C | -25 ... +50 °C | 65 / 50 °C | 3.83 kΩ |
| 1,750 mA | 14 V | 31.4 V | 55.0 W | 62.5 W | 277 mA | 0.98 | 65 °C | -25 ... +50 °C | 65 / 50 °C | short circuit | |

^① Min. output voltage LED Driver is 26 V by using the accessory LCF 12V FAN DRIVER.

Product description

- Ready-for-use resistor to set output current value
- Resistor is base isolated
- Resistor power 0.25 W
- Resistor value tolerance $\pm 1\%$

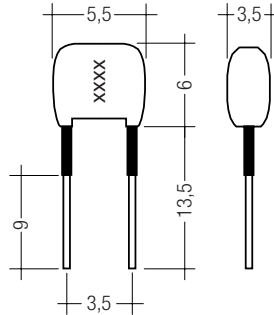

Ordering data

| Type | Article number | Colour | Marking | Resistor value | Packaging bag | Weight per pc. |
|-------------------------|----------------|--------|---------|------------------|---------------|----------------|
| I-SELECT PLUG 950mA BR | 28000370 | Brown | 0950 | 69.80 k Ω | 10 pc(s). | 0.001 kg |
| I-SELECT PLUG 1000mA BR | 28000459 | Brown | 1000 | 64.90 k Ω | 10 pc(s). | 0.001 kg |
| I-SELECT PLUG 1050mA BR | 28000279 | Brown | 1050 | 56.00 k Ω | 10 pc(s). | 0.001 kg |
| I-SELECT PLUG 1100mA BR | 28000460 | Brown | 1100 | 47.50 k Ω | 10 pc(s). | 0.001 kg |
| I-SELECT PLUG 1200mA BR | 28000461 | Brown | 1200 | 40.20 k Ω | 10 pc(s). | 0.001 kg |
| I-SELECT PLUG 1300mA BR | 28000462 | Brown | 1300 | 32.40 k Ω | 10 pc(s). | 0.001 kg |
| I-SELECT PLUG 1400mA BR | 28000280 | Brown | 1400 | 22.00 k Ω | 10 pc(s). | 0.001 kg |
| I-SELECT PLUG 1500mA BR | 28000464 | Brown | 1500 | 15.00 k Ω | 10 pc(s). | 0.001 kg |
| I-SELECT PLUG 1600mA BR | 28000464 | Brown | 1600 | 9.30 k Ω | 10 pc(s). | 0.001 kg |
| I-SELECT PLUG 1700mA BR | 28000464 | Brown | 1700 | 3.83 k Ω | 10 pc(s). | 0.001 kg |
| I-SELECT PLUG MAX GR | 28000274 | Grey | MAX | 0 Ω | 10 pc(s). | 0.001 kg |

Product description

- Fan driver module with 12.4 V output voltage
- Drives the fan permanently (independent of the optional temperature sensor)
- Terminal IN1 / IN2: stranded wires 0.2 mm², stripped wire endings twisted and tin-plated
- Terminal FAN+ / FAN- and OUT1 / OUT2: 0.2 – 0.75 mm² solid or stranded wires twisted and tin-plated, strip wires 6 – 7 mm
- Max. output power of the LED Driver will be reduced by the power consumption of the fan and LCF 12V FAN DRIVER



Technical data

| | |
|--|-----------------|
| Input voltage, DC | 25 – 120 V |
| Output voltage DC | 12.4 V |
| Max. output current (input voltage 25 – 49 V) | 50 mA |
| Max. output current (input voltage 50 – 120 V) | 70 mA |
| Max. power consumption incl. fan (at 30 mA) | 0.55 W |
| Max. power consumption incl. fan (at 50 mA) | 0.90 W |
| Max. power consumption incl. fan (at 70 mA) | 1.25 W |
| tc point | 75 °C |
| Ambient temperature ta (at life-time 50,000 h) | -25 ... +65 °C |
| Dimensions LxWxH | 45 x 23 x 14 mm |

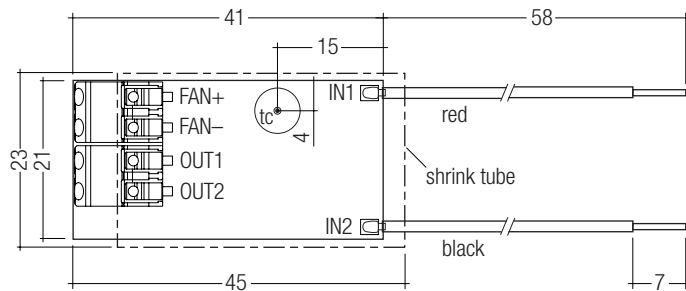

Ordering data

| Type | Article number | Packaging carton | Packaging pallet | Weight per pc. |
|--------------------|----------------|------------------|------------------|----------------|
| LCF 12V FAN DRIVER | 28000932 | 50 pc(s). | 1,200 pc(s). | 0.01 kg |

Standards

EN 55015
EN 61000-3-2
EN 61000-3-3
EN 61347-2-13
EN 62384
EN 61547
According to EN 50172 for use in central battery systems
According to EN 60598-2-22 suitable for emergency lighting installations

Output current setting

Output current can be set by connecting a resistor between the 2 "I sel" terminals. Relationship between output current and resistor value can be found at the table "Specific technical data". Resistor values specified from standardised resistor value ranges.

Resistor value tolerance has to be $\leq 1\%$.

Resistor power has to be $\geq 0.1\text{ W}$.

If the resistor is connected with wires a max. wire length of 2 m may not be exceeded and possible interferences have to be avoided.

Resistor detection at each start. Change of the resistor value during the operation will be not considered. Resistors for the main output current values can be ordered from Tridonic (see accessories).

DC emergency operation

The LED Driver is designed for operation on DC voltage and pulsed DC voltage.

Light output level in DC operation (E_{OF,λ}): 100% (cannot be adjusted)

The voltage-dependent input current of Driver incl. LED module is depending on the used load.

The voltage-dependent no-load current of Driver (without or defect LED module) is for:

AC: < 25 mA

DC: < 8 mA

Overload protection

LED Driver will switch off at overload operation. Mains reset is required to restart the LED Driver.

Underload operation

LED Driver will switch off at underload operation. Mains reset is required to restart the LED Driver.

Overtemperature protection

The LED Driver will reduce output current at temporary thermal over-heating (exceeding max. t_c point).

On DC operation this function is deactivated to fulfill emergency requirements.

Short-circuit behaviour

LED Driver will switch off in case of short-circuit of LED output. Mains reset is required to restart the LED Driver.

No-load operation or load loss during operation

LED Driver will detect a load loss during operation. In this case and no-load operation the max. output voltage can apply at the LED output for max. 5 s before LED Driver shuts down. Mains reset is required to restart the LED Driver.

Hot plug-in

Hot plug-in is not recommend within 5 s after shutdown due to output voltage of > 0 V. Mains reset is required to restart the LED Driver if LED module is connected to the LED Driver after these 5 s.

Intelligent Temperature Management (ITM)

ITM offers the possibility to protect the LED module against thermal overload.

Therefore it is necessary to connect the temperature sensor (KTY81/210, KTY82/210) to the corresponding terminals.

If the limit temperature will be exceeded the LED output current will be reduced respectively switched off. After achieving the nominal temperature the LED output current will be increased to the set value again.

Using NTC or PTC resistors is not permitted.

The LED Driver can be used without sensor as well.

Conditions of use and storage

Humidity: 5% up to max. 85%,
not condensed
(max. 56 days/year at 85%)

Storage temperature: -40 °C up to max. +80 °C

The devices have to be within the specified temperature range (t_a) before they can be operated.

Glow-wire test

according to EN 60598-1 with increased temperature of 960 °C passed.

Temperature range

The LED Driver life duration is related to the ambient temperature t_a. The relation of t_c to t_a temperature depends also on the luminaire design. If the measured t_c temperature is approx. 5 K below t_c max. or higher, t_a temperature should be checked and eventually critical components (e.g. ELCAP) measured.

Detailed information on request.

Expected life-time

| Type | Output current | t _a | 40 °C | 50 °C | 55 °C | 60 °C |
|-----------------------------|------------------|----------------|-------------|----------|----------|-------|
| LCI 55W 900mA-1750mA TOP SR | 900 – 1,050 mA | t _c | 55 °C | 65 °C | 70 °C | x |
| | | Life-time | > 100,000 h | 80,000 h | 60,000 h | x |
| | 1,100 – 1,750 mA | t _c | 55 °C | 65 °C | x | x |
| | | Life-time | > 100,000 h | 55,000 h | x | x |

x = not permitted

The LED Driver is designed for a life-time stated above under reference conditions and with a failure probability of less than 10 %.

Maximum loading of automatic circuit breakers

| Automatic circuit breaker type | C10 | C13 | C16 | C20 | B10 | B13 | B16 | B20 | Inrush current |
|------------------------------------|---------------------|---------------------|---------------------|---------------------|---------------------|---------------------|---------------------|---------------------|-----------------------|
| Installation Ø | 1,5 mm ² | 1,5 mm ² | 2,5 mm ² | 2,5 mm ² | 1,5 mm ² | 1,5 mm ² | 2,5 mm ² | 2,5 mm ² | I _{max} time |
| LCI 55W 900mA-1750mA TOP SR | 18 | 24 | 28 | 34 | 9 | 12 | 14 | 17 | 20 A 200 µs |

Harmonic distortion in the mains supply (at 230 V / 50 Hz and full load) in %

| | THD | 3. | 5. | 7. | 9. | 11. |
|------------------------------------|-----|----|----|----|----|-----|
| LCI 55W 900mA-1750mA TOP SR | 10 | 8 | 4 | 4 | 2 | 1 |

Installation instructions

Mains supply wires

Wiring type and cross section

Stranded wire or solid wire up to 2.5 mm² may be used for wiring.

Strip 10–11 mm of insulation from the cables to ensure perfect operation of the push terminals.

Use one wire for each terminal connector only.

Use each strain relief channel for one cable only.

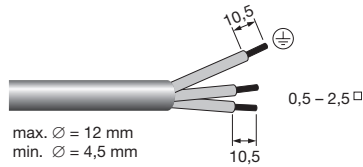

Secondary wires (LED module)

Wiring type and cross section

The wiring can be in stranded wires with ferrules or solid with a cross section of 0.2–1.5 mm².

Strip 8.5–9.5 mm of insulation from the cables to ensure perfect operation of the push-wire terminals.

Use one wire for each terminal connector only.

Use each strain relief channel for one cable only.

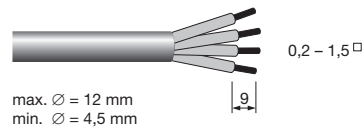

Fixing conditions

Dry, acidfree, oilfree, fatfree. It is not allowed to exceed the maximum ambient temperature (t_a) stated on the device. Minimum distances stated below are recommendations and depend on the actual luminaire.

Is not suitable for fixing in corner.

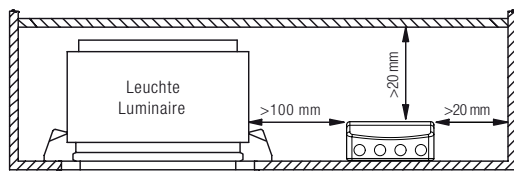

Release of the wiring

Press down the "push button" and remove the cable from front.

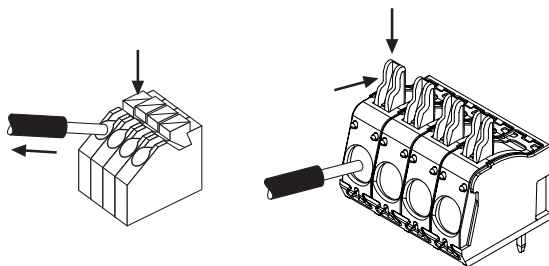

Wiring guidelines

- All connections must be kept as short as possible to ensure good EMI behaviour.
- Earthing is not required for the device to operate but will improve the EMI behaviour.
- If LCI TOP SR will be earthed protection earth (PE) has to be used.
- Mains leads should be kept apart from LED Driver and other leads (ideally 5 – 10 cm distance)
- Max. length of output and I sel wires is 2 m.
- Secondary switching is not permitted.
- Incorrect wiring can damage LED modules.
- Through wiring of mains is for connecting additional LED Driver only. Max. permanent current of 12 A may not be exceeded.
- The wiring must be protected against short circuits to earth (sharp edged metal parts, metal cable clips, louver, etc.).

Earth connection

The earth connection is conducted as protection earth (PE). If the LED Driver will be earthed, protection earth (PE) has to be used. There is no earth connection required for the functionality of the LED Driver. Earth connection is recommended to improve following behaviour.

- Electromagnetic interferences (EMI)
- Transmission of mains transients to the LED output

In general it is recommended to earth the LED Driver if the LED module is mounted on earthed luminaire parts respectively heat sinks and thereby representing a high capacity against earth.

Isolation and electric strength testing of luminaires

Electronic devices can be damaged by high voltage. This has to be considered during the routine testing of the luminaires in production.

According to IEC 60598-1 Annex Q (informative only!) or ENEC 303-Annex A, each luminaire should be submitted to an isolation test with 500 V_{DC} for 1 second. This test voltage should be connected between the interconnected phase and neutral terminals and the earth terminal. The isolation resistance must be at least 2 MΩ.

As an alternative, IEC 60598-1 Annex Q describes a test of the electrical strength with 1500 V_{AC} (or 1.414 x 1500 V_{DC}). To avoid damage to the electronic devices this test must not be conducted.

Additional information

Additional technical information at www.tridonic.com → Technical Data

Guarantee conditions at www.tridonic.com → Services

Life-time declarations are informative and represent no warranty claim. No warranty if device was opened.

Circuit diagram

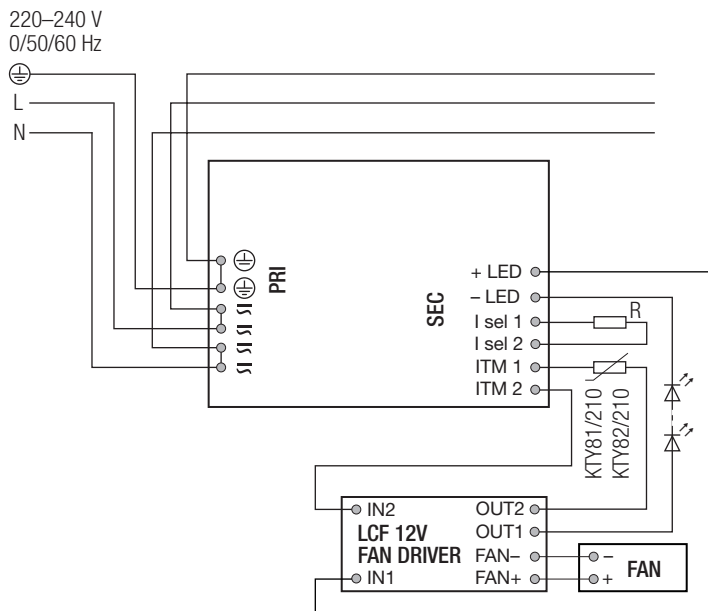
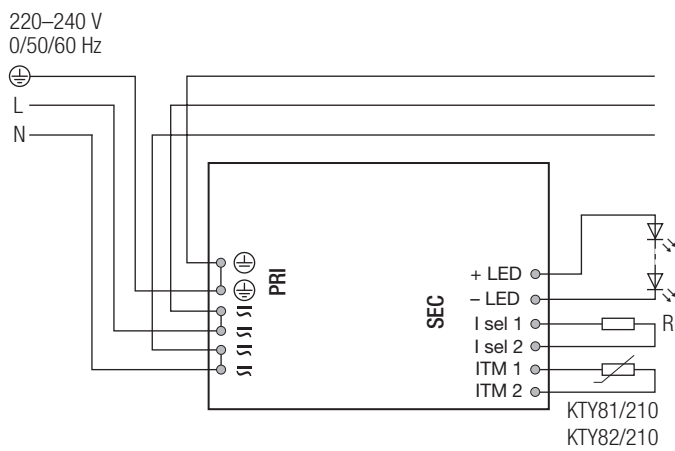

Diagrams LCI 55W 900mA-1750mA TOP SR

Efficiency vs load

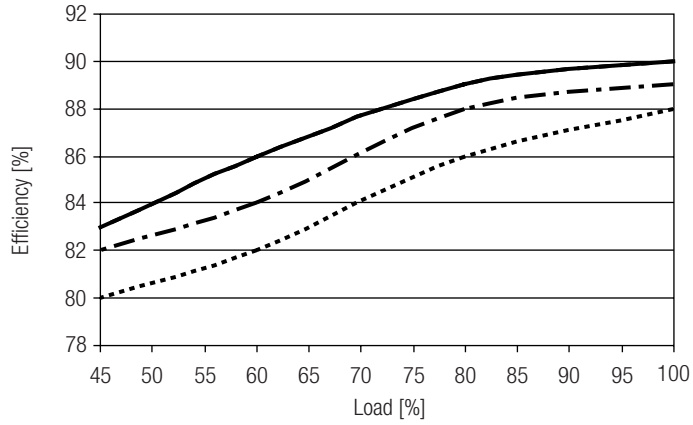

Power factor vs load

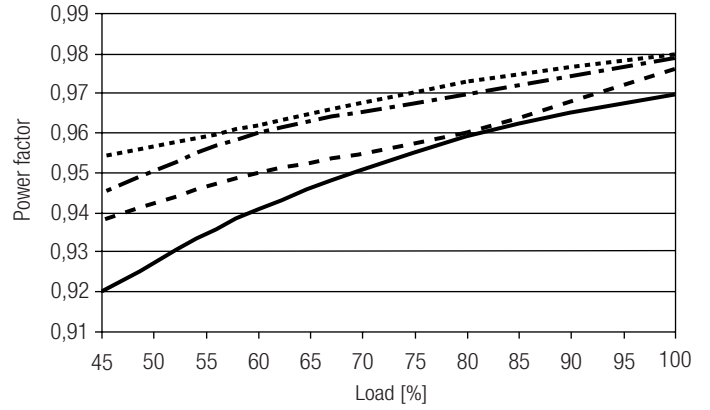

Input power vs load

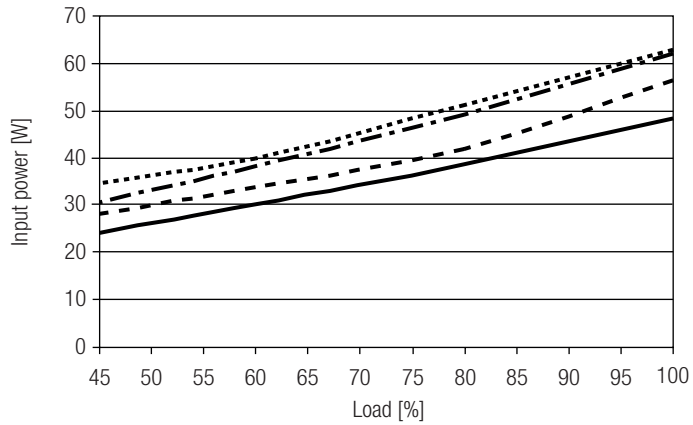

Input current vs load

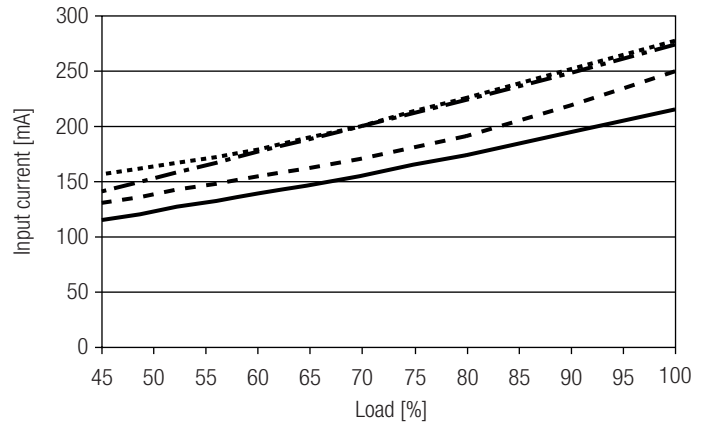

THD vs load

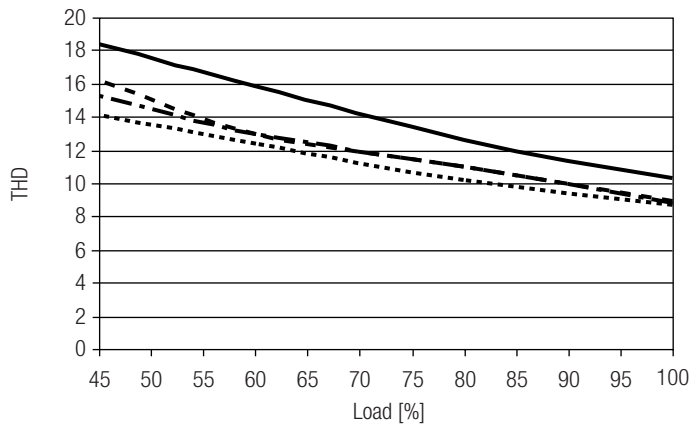

- 900 mA
- - - 1050 mA
- · - · 1400 mA
- · · · 1750 mA