

 Create pdf

Lampholders for low voltage halogen lamps

25.126.3501

GY6.35 / Connector GX5.3

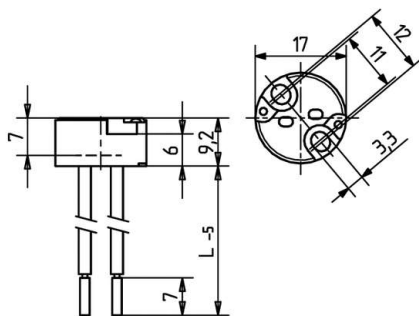

pkg.	wt.	part no.
500	8 g	25.126.3501.00

Connection: Rear cable entry

Wires: Cu, nickel plated 1.0 mm², with ferrule,
Insulation PTFE (max. 250° C), Free cable
length: 140 mm

Connector GX5.3

Screw fixing

Housing: Ceramic / Mica plate

Contacts: Ni

- The method of wiring must be such that no stress or bending motions will be transferred to the contacts, thus reducing the contact / pressure on the lamp pins.
- Other versions on request.

T 300	10 A 50 V
-------	--------------

Document generated on: Th, 9. February 2017 - 15:32